



IT'S ELECTRIC TIGERSHARK LINERIGGER®

TOP MOUNT OUTRIGGER HOLDERS



TIGERSHARK I - SAY HELLO TO SIMPLICITY!!

THE SIMPLICITY OF PRESSING A SWITCH AND YOU'RE FISHING!!

THE TIGERSHARK I LINERIGGER® IS THE FIRST ELECTRONICALLY OPERATED TOP-MOUNT OUTRIGGER HOLDER OFFERED TO THE MARKET PLACE. **DESIGNED FOR EITHER HARD OR SOFT TOPS INSTALLATIONS.**

METICULOUS ENGINEERING PROVIDES EXACT ELECTRONIC DEPLOYMENT OF YOUR OUTRIGGERS FROM YOUR CONSOLE. THE POWERFUL 12V MOTOR DRIVE ALLOWS FOR THE TOTAL DEPLOYMENT AND/OR ADJUSTMENT BY SIMPLY PRESSING THE SWITCH UP. RETRIEVAL OF YOUR OUTRIGGERS IS JUST AS EASY, BY SIMPLY PRESSING THE ACTUATOR SWITCH DOWN AND YOUR OUTRIGGERS RETURN TO THEIR RESTING POSITION. **WILL FIT ALL PREPARED T-TOPS WITH 3" MOUNTING HOLE. MOUNTING PLATE SIZE: 4" W X 6" L.**

UNITS ARE SUPPLIED WITH A STANDARD DUAL ROCKER SWITCH PANEL, WHEN ACTIVATED SIMULTANEOUSLY RAISES AND DEPLOYS YOUR OUTRIGGERS TO THE FISHING POSITION. CONVENIENCE, CRAFTSMANSHIP, QUALITY AND PERFORMANCE WILL MAKE THE TIGERSHARK A TOP SELECTION FOR THE SPORTS-FISHERMAN.

MADE IN THE USA

#88800 - ELECTRIC TOP MOUNT DESIGNED TO FIT EITHER HARD OR SOFT TOP.



**UP & OUT
IN ONLY
25 SECONDS**

MANUAL MODEL TIGERSHARK LINERIGGER®

TOP MOUNT OUTRIGGER HOLDERS



PATENT
PENDING



TIGERSHARK II & III- SAY HELLO TO SIMPLICITY!!

THE SIMPLICITY OF TURNING A HANDLE AND YOU'RE FISHING!!

FINALLY, THE FIRST TOP MOUNT OUTRIGGER HOLDER TO OFFER COMPLETE MANUAL OUTRIGGER DEPLOYMENT FROM YOUR CONSOLE. THIS INNOVATIVE ENGINEERED PRODUCT ALLOWS FOR ADJUSTMENTS TO CLEAR LOW OBSTACLES OR QUICKLY ADJUST YOUR OUTRIGGERS TO MAXIMUM BAIT SPREAD. THE SIMULTANEOUS UP AND OUT MOTION ELIMINATES NEEDING TO CLIMB THE GUNNELS TO ADJUST YOUR OUTRIGGERS. A SIMPLE TURN OF THE HANDLE DOES IT ALL, TOTAL DEPLOYMENT AND TOTAL POSITION ADJUSTMENT. WILL FIT ALL PREPARED T-TOPS WITH 3" MOUNTING HOLE. MOUNTING PLATE SIZE: 4" W X 6" L. METICULOUS CRAFTSMANSHIP, QUALITY, PERFORMANCE AND CONVENIENCE WILL PROPEL THESE TIGERSHARK MANUAL UNITS TO A TOP SELECTION FOR THE SPORTS-FISHERMAN.

MADE IN THE USA

#88802 - MANUAL TOP MOUNTS FOR SOFT TOPS
#88803 - MANUAL TOP MOUNTS FOR HARD TOPS UP TO 2 1/2"

THE NEWEST OF OUR TIGERSHARK SERIES OF TOP MOUNT OUTRIGGER HOLDERS.

THIS MODEL FEATURES A BOTTOM MOUNTED CRANK ASSEMBLY FOR EASE OF DEPLOYMENT. **SIMPLY PUSH UP ON THE HANDLE TO RELEASE THE GEARS AND TURN 10 TO 12 TIMES TO COMPLETE DEPLOYMENT OF YOUR OUTRIGGERS TO MAXIMUM BAIT SPREAD.** THEN SIMPLY PULL HANDLE DOWN TO LOCK INTO PLACE.

SIMULTANEOUS UP AND OUT MOTION ELIMINATES CLIMBING THE GUNNELS TO ADJUST YOUR OUTRIGGERS, A SIMPLE TURN OF THE HANDLE DOES IT ALL. TOTAL DEPLOYMENT AND POSITION ADJUSTMENT. WILL FIT ALL PREPARED T-TOPS WITH 3" MOUNTING HOLE AND ALL HARD TOPS UP TO 2 1/2" THICK WITH PREDRILLED HOLES. ALLOWING FOR THE LOWEST PROFILE UNDER YOUR T-TOP OR HARD TOP OF ANY TOP MOUNT OUTRIGGER HOLDER IN THE INDUSTRY.

MADE IN THE USA

#88805 - MANUAL TOP MOUNTS DESIGNED FOR HARD TOPS AND SOFT TOPS

TIGRESS TRACK® PREMIUM TELESCOPING ALUMINUM OUTRIGGER POLES

PATENTED

#7,025,015 B2



TIGRESS TRACK® PATENTED TELESCOPING OUTRIGGERS ARE AVAILABLE IN 3 POPULAR SIZES AND COLORS. FEATURES OUR EXCLUSIVE INTERNAL TRACK® SYSTEM. "ALWAYS LINE UP TO NEVER MISS THE HOLE" FOR EASIER DEPLOYMENT AND RETRACTION! TIGRESS OUTRIGGERS ALSO RETRACT TO UNDER 6' FOR TRAILERING, BRIDGES AND STORAGE. OUTRIGGERS ARE CONSTRUCTED OF COLD DRAWN ALUMINUM, ANODIZED INSIDE AND OUT FOR OVERALL DURABILITY AND STYLE. FEATURES STAINLESS STEEL EYE GUIDES, STAINLESS STEEL SNAP BUTTONS AND ANODIZED ALUMINUM TRIM RINGS. EACH PAIR OF POLES INCLUDES A HANDY HEAVY DUTY MESH STORAGE BAG TO PROTECT THE POLES FROM SCRATCHING WHEN STORED. AVAILABLE IN BLACK WITH GOLD TRIM RINGS, SILVER WITH BLACK TRIM RINGS AND BLUE WITH GOLD TRIM RINGS.

15' - 1 1/8" OUTSIDE DIAMETER BASE

- #88900 - 15' BLACK WITH GOLD TRIM RINGS
- #88901 - 15' SILVER WITH BLACK TRIM RINGS
- #88903 - 15' BLUE WITH GOLD TRIM RINGS FOR

15' - 1 1/2" OUTSIDE DIAMETER BASE

- #88904 - 15' HD BLACK WITH GOLD TRIM RINGS
- #88905 - 15' HD SILVER WITH BLACK TRIM RINGS
- #88906 - 15' HD BLUE WITH GOLD TRIM RINGS

18' - 1 1/2" OUTSIDE DIAMETER BASE

- #88908 - 18' HD BLACK WITH GOLD TRIM RINGS
- #88909 - 18' HD SILVER WITH BLACK TRIM RINGS
- #88910 - 18' HD BLUE WITH GOLD TRIM RINGS

TIGRESS EXCALIBUR 100% CARBON GRAPHITE TELESCOPING OUTRIGGERS & CENTER RIGGER



TIGRESS TRACK® TELESCOPING CARBON GRAPHITE OUTRIGGERS & CENTER RIGGERS (Patented #7,025,015 B2)

THE FIRST TELESCOPING CARBON GRAPHITE OUTRIGGER AVAILABLE TO THE SPORTFISHING ENTHUSIAST. FEATURING OUR PATENTED TIGRESS TRACK® INTERNAL TRACKING SYSTEM. "TO ALWAYS LINE UP AND NEVER MISS THE HOLE". OUR PROPRIETARY MANUFACTURING PROCESS UTILIZES MULTIPLE LAYERS OF CARBON GRAPHITE AND UV STABLE EPOXY TAPE COUNTER WRAPPED USING TENSION, PRESSURE, AND CURE TIME TO CREATE THE STRONGEST WEIGHT TO STRENGTH RATIO POSSIBLE, WHILE CREATING THE LIGHTEST TELESCOPING OUTRIGGER IN THE INDUSTRY.

(NEW) #88976 - 18' 1-1/2" BLACK/BLACK CARBON GRAPHITE OUTRIGGERS

(NEW) #88976-1 9' 1-1/8" BLACK/BLACK CARBON GRAPHITE CENTER RIGGER

TIGRESS® CARBON GRAPHITE FIXED OUTRIGGERS

UTILIZING THE SAME PROPRIETARY MANUFACTURING SYSTEM AS OUR TELESCOPING CARBON OUTRIGGERS THESE FIXED CARBON GRAPHITE OUTRIGGERS OFFER A UNIQUE COUPLING SYSTEM MADE OF ANODIZED MARINE ALUMINUM WITH POLISHED STAINLESS EYE GUIDE FITTED TO EACH



COUPLER. **1 1/2" FIXED OUTRIGGERS**

- #88970 - 15' CHROME WITH BLACK TRIM RINGS
- #88971 - 18' CHROME WITH BLACK TRIM RINGS
- #88972 - 22' CHROME WITH BLACK TRIM RINGS
- #88973 - 15' BLACK WITH GOLD TRIM RINGS
- #88974 - 18' BLACK WITH GOLD TRIM RINGS
- #88975 - 22' BLACK WITH GOLD TRIM RINGS

TIGRESS® PREMIUM FIXED ALUMINUM OUTRIGGERS

THE SAME QUALITY AS OUR PREMIUM TELESCOPING OUTRIGGERS, BUT IN A FIXED MODEL. BOTH THE BLACK/GOLD AND SILVER/BLACK MODELS ARE CONSTRUCTED OF ANODIZED ALUMINUM WITH COLOR TRIM RINGS AND STAINLESS STEEL LINE GUIDES. FITS MOST 1 1/8" AND 1 1/2" ID OUTRIGGER TUBES.



15' - 1 1/8" OUTSIDE DIAMETER BASE

- #88400 - BLACK WITH GOLD TRIM RINGS
- #88401 - SILVER WITH BLACK TRIM RINGS

15' - 1 1/2" OUTSIDE DIAMETER BASE

- #88403 - BLACK WITH GOLD TRIM RINGS
- #88404 - SILVER WITH BLACK TRIM RINGS

18' - 1 1/2" OUTSIDE DIAMETER BASE

- #88405 - BLACK WITH GOLD TRIM RINGS
- #88406 - SILVER WITH BLACK TRIM RINGS

NEW

OUTRIGGER HOLDER REDUCERS

REDUCE YOUR OUTRIGGER HOLDERS DOWN!

- #88680 REDUCE FROM 1 1/2" - 1 1/8"
- #88681 REDUCE FROM 1 5/8" - 1 1/2"
- #88680-1 REDUCE FROM 1 7/8" - 1 1/2"

TIGRESS® TELESCOPING FIBERGLASS OUTRIGGERS

AN ECONOMICAL ALTERNATIVE TO ALUMINUM OUTRIGGERS FOR 18' TO 28' BOATS. 15' TELESCOPING, THREE-SECTION, HEAVY DUTY FIBERGLASS OUTRIGGERS FEATURE HEAVY LINE GUIDES FOR EASY RIGGING. INCLUDES A VINYL BAG FOR STORAGE. 1-1/8" BASE WILL FIT MOST OUTRIGGER HOLDERS. RETRACTS TO LESS THAN 6'.
#88201 - 15' 1 1/8" WHITE AND BLUE
#88201- 15' 1 1/8" BLACK AND GOLD



TIGRESS® ECONOMY 15' FIXED ALUMINUM OUTRIGGERS

CONSTRUCTED OF HEAVY DUTY ANODIZED ALUMINUM WITH NYLON GUIDE ASSEMBLY AND STAINLESS STEEL LINE GUIDES, FOUR SECTION, SCREW TOGETHER ASSEMBLY WITH BLACK ANODIZED ALUMINUM TIP. FITS MOST HOLDERS WITH 1 1/8" ID TUBE,
#88220 - SILVER WITH BLACK RINGS



TIGRESS TRACK® CENTER RIGGER

FINALLY A TELESCOPING CENTER RIGGER AVAILABLE IN 8' WITH 1-1/8" OD BASE. COMBINE IT WITH OUR CLAMP-ON CENTER RIGGER HOLDER AND OUR CENTER RIGGER KIT. FOR MULTIPLE LINES IN THE WATER. RETRACTS TO LESS TO 5'.



1-1/8" OD BASE

#88914 - 8' BLACK WITH GOLD RINGS

#88915 - 8' SILVER WITH BLACK RINGS

#88916 - 8' BLUE WITH GOLD RINGS

OUTRIGGER ACCESSORIES

#88685: OUTRIGGER CARRY BAG FOR 15' TO 18' TELESCOPING OUTRIGGERS



#88677: OUTRIGGER STANDOFF USED TO STABILIZE YOUR OUTRIGGERS IN RESTING POSITION BY SIMPLY INSERTING INTO YOUR EXISTING WELD-ON ROD HOLDER.

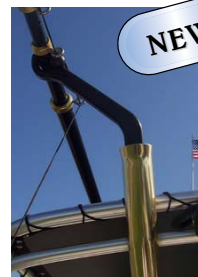

TIGRESS TRACK® II PREMIUM TELESCOPING SYSTEMS



1 1/8" TIGERFISH II T-TOP SYSTEM

INCLUDES A PAIR OF TIGERFISH II T-TOP HOLDERS, A PAIR OF TIGRESS TRACK® TELESCOPING OUTRIGGERS, A PREMIUM DELUXE RIGGING KIT AND A BLACK MESH CARRY BAG FOR STORAGE OF YOUR NEW SYSTEM.

- #88900-1 15' BLACK & GOLD SYSTEM
- #88901-1 15' SILVER & BLACK SYSTEM
- #88903-1 15' BLUE & GOLD SYSTEM

TIGRESS TRACK® I PREMIUM TELESCOPING SYSTEMS



1 1/2" TIGERFISH I T-TOP SYSTEM

INCLUDES A PAIR OF TIGERFISH I T-TOP HOLDERS, A PAIR OF TIGRESS TRACK® TELESCOPING OUTRIGGERS, A PREMIUM DELUXE RIGGING KIT AND A BLACK MESH CARRY BAG FOR STORAGE OF YOUR NEW SYSTEM.

- #88905-1 15' HD BLACK & GOLD SYSTEM
 - #88906-1 15' HD SILVER & BLACK SYSTEM
 - #88907-1 15' HD BLUE & GOLD SYSTEM
- ALSO AVAILABLE WITH 18' OUTRIGGERS

TIGERFISH T-TOP CLAMP-ON SYSTEMS w/TIGRESS TRACK® TELESCOPING OUTRIGGERS



TIGERFISH T-TOP ADJUSTABLE CLAMP-ON OUTRIGGER HOLDERS. PUT ABSOLUTELY NO MORE HOLES IN THE GUN WHALE OF YOUR BOAT. SIMPLY DRILL 1/4" HOLE INTO YOUR SCHEDULE PIPE AND CLAMP-ON. ALL CLAMPS ARE SIZED FOR SCHEDULE 40 PIPE ONLY AS BELOW. PLEASE CONFIRM SIZE 1.315 OR 1.660 WITH RULER ON PAGE 16. ALSO AVAILABLE WITH 1 1/2" (1.90) CLAMP-ONS AND 18' OUTRIGGERS.

- #88965-00 - 1"(1.315) CLAMPS X 15' X 1 1/8" BASE
BLACK WITH GOLD SYSTEM
- #88965-01 - 1"(1.315) CLAMPS X 15' X 1 1/8" BASE
SILVER WITH BLACK SYSTEM
- #88966-00 - 1 1/4"(1.660) CLAMPS X 15' X 1 1/2" BASE
BLACK WITH GOLD SYSTEM
- #88966-01 - 1 1/4"(1.660) CLAMPS X 15' X 1 1/2" BASE
SILVER WITH BLACK SYSTEM

1 1/2" ALSO AVAILABLE WITH 18' OUTRIGGERS

FIBERGLASS TELESCOPING OUTRIGGER SYSTEMS



THE ECONOMICAL VERSION OF A TELESCOPING OUTRIGGER SYSTEM. COMPLETE FIBERGLASS KIT INCLUDES, A PAIR OF 15 X 1 1/8" FIBERGLASS POLES, A PAIR 1 1/8" FABRICATED FLUSH MOUNT OUTRIGGER HOLDERS AND ECONOMY RIGGING KIT.

#88200-1 - WHITE AND BLUE POLES COMPLETE KIT

#88201-1 - BLACK AND GOLD POLES COMPLETE KIT

TIGRESS TRACK® CENTER RIGGER SYSTEMS



FINALLY A TELESCOPING CENTER RIGGER AVAILABLE IN 8' 1-1/8" OD BASE, COMBINED WITH OUR CLAMP-ON CENTER RIGGER HOLDER AND OUR CENTER RIGGER KIT. FOR MULTIPLE LINES IN THE WATER.

HOLDER SIZED TO FIT 1.315 SCHEDULE PIPE.

#88917 - BLACK WITH GOLD TRIM RINGS SYSTEM

#88918 - SILVER WITH BLACK TRIM RINGS SYSTEM

#88919 - BLUE WITH GOLD TRIM RINGS SYSTEM

TIGERFISH ROD HOLDER/OUTRIGGER SYSTEMS w/TIGRESS TRACK® TELESCOPING OUTRIGGERS



ADJUSTABLE, PLACE IN YOUR ALREADY EXISTING CAST STAINLESS ROD HOLDER/OUTRIGGER HOLDER. PUT ABSOLUTELY NO MORE HOLES IN THE GUNNEL OF YOUR BOAT. ALSO FOR WHEN YOUR NOT USING YOUR OUTRIGGER SIMPLY REMOVE FROM YOUR CAST ROD HOLDER.

#88968-00 - 1 5/8" BASE X 15' X 1 1/8" HOLDER BLACK WITH GOLD SYSTEM

#88968-01 - 1 5/8" BASE X 15' X 1 1/8" HOLDER SILVER WITH BLACK SYSTEM

#88969-00 - 1 5/8" BASE X 15' X 1 1/2" HOLDER BLACK WITH GOLD SYSTEM

#88969-01 - 1 5/8" BASE X 15' X 1 1/2" HOLDER SILVER WITH BLACK SYSTEM

1 1/2" ALSO AVAILABLE WITH 18' OUTRIGGERS

TigerFish



Patent # US
7,197,845 B2

OUR PATENTED 1 1/2" TOP MOUNT OUTRIGGER HOLDERS ARE, CONSTRUCTED OF ALUMINUM AND STAINLESS STEEL OR ALL STAINLESS STEEL. DEPLOY YOUR OUTRIGGERS WITHOUT LEAVING YOUR CONSOLE! CONSTRUCTED OF MARINE ALUMINUM AND STAINLESS STEEL WITH SELF-LUBRICATING BEARINGS, USES NO GREASE AND THERE IS NO METAL TO METAL CONTACT. HEAVY DUTY ISOLATOR PAD INCLUDED TO PREVENT DISSIMILAR METAL CONTACT WHEN MOUNTING STAINLESS STEEL MODEL ON ALUMINUM T-TOPS. ALL STAINLESS STEEL MODEL IS AVAILABLE AS ADJUSTABLE MODEL ONLY.

#88952 – FIXED 55°, 1-1/2" ID TUBE
#88954 – ADJUSTABLE, ALL STAINLESS, 1-1/2" ID TUBE

***FOR THOSE ANGLED TOPS. TIGRESS NOW OFFERS 3 ANGULAR ADJUSTING WEDGES TO STRAIGHTEN THE TOP MOUNT IN INSTALLATION ALLOWING FOR LESS STRESS ON THE TOP AND SMOOTHER DEPLOYMENT OF YOUR OUTRIGGERS.**

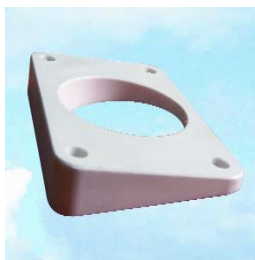

#88934 - 7° ANGULAR ADJUSTING WEDGE
#88936 - 9° ANGULAR ADJUSTING WEDGE
#88938 - 11° ANGULAR ADJUSTING WEDGE

TIGERFISH T-TOP ADJUSTABLE CLAMP-ON



Patent # US
7,296,377

PUT ABSOLUTELY NO MORE HOLES IN YOUR HARD TOP OR THE GUNNEL OF YOUR BOAT. SIMPLY DRILL 1/4" HOLE INTO THE SCHEDULE PIPE OF YOUR T-TOP AND CLAMP-ON.

#88965 - 1" (1.315 ID) ADJUSTABLE CLAMP-ON WITH 1 1/8" HOLDER
#88966 - 1 1/4" (1.660 ID) ADJUSTABLE CLAMP-ON WITH 1 1/2" HOLDER
#88967 - 1 1/2" (1.90 ID) ADJUSTABLE CLAMP-ON WITH 1 1/2" HOLDER

TigerFish I & II



Patent # US
7,197,845 B2

TIGERFISH 1 1/8" AND 1 1/2" TOP MOUNT OUTRIGGER HOLDERS ARE, CONSTRUCTED OF ALUMINUM AND STAINLESS STEEL OR ALL STAINLESS STEEL WITH SELF-LUBRICATING BEARINGS FOR EASE OF DEPLOYMENT AND YEARS OF DURABILITY AND USE. NO MORE CLIMBING YOUR GUNNEL IN HEAVY SEAS TO DEPLOY YOUR OUTRIGGERS. HEAVY DUTY ISOLATOR PAD INCLUDED TO PREVENT DISSIMILAR METAL CONTACT WHEN MOUNTING STAINLESS STEEL MODEL ON ALUMINUM T-TOPS. DEPLOYS SIMPLY FROM YOUR CONSOLE.

#88960 – ADJUSTABLE, 1-1/8" ID HOLDER
#88950 – ADJUSTABLE, 1-1/2" ID HOLDER

TIGERFISH ROD HOLDER/OUTRIGGER HOLDERS



Patent # US
7,296,377

PUT ABSOLUTELY NO MORE HOLES IN YOUR T-TOP OR THE GUNNEL OF YOUR BOAT. SIMPLY PLACE INTO YOUR EXISTING CAST STAINLESS ROD HOLDER WHEN OUTRIGGERS ARE NEEDED. WHEN OUTRIGGERS ARE NOT IN USE SIMPLY REMOVE HOLDERS AND YOUR EXISTING CAST ROD HOLDER IS USABLE AGAIN.

#88968 - 1 5/8" ROD HOLDER/OUTRIGGER HOLDER W/ 1 1/8" BASE
#88969 - 1 5/8" ROD HOLDER/OUTRIGGER HOLDER W/ 1 1/2" BASE

1 1/8" & 1 1/2" OUTRIGGER HOLDERS AND REPLACEMENT TUBES



GUNNEL MOUNT

#88500 – 1 1/8" ID FABRICATED GUNNEL MOUNT HOLDERS

#88502 – 1 1/8" ID CAST 316 STAINLESS STEEL GUNNEL MOUNT HOLDERS

#88506 - 1 1/2" ID CAST 316 STAINLESS STEEL GUNNEL MOUNT HOLDERS

SIDE MOUNTS

#88504 – 1 1/8" ID FABRICATED SIDE MOUNT HOLDERS

#88505 – 1 1/8" ID CAST 316 STAINLESS STEEL SIDE MOUNT HOLDERS

#88508 - 1 1/2" ID CAST 316 STAINLESS STEEL SIDE MOUNT HOLDERS

REPLACEMENT TUBES

#88501 – 1 1/8" ID CAST 316 STAINLESS STEEL TUBE

#88503 – 1 1/8" ID CUT 304 STAINLESS TUBE

#88507 - 1 1/2" ID CAST 316 STAINLESS STEEL TUBE

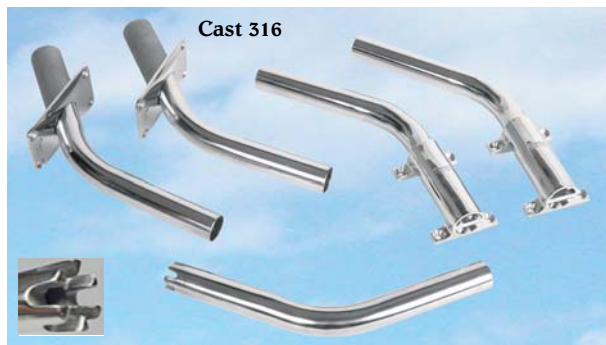

GUNNEL & SIDE MOUNT BACKING PLATES



OUR FLUSH MOUNT AND SIDE MOUNT BACKING PLATES ARE MADE OF HEAVY GAUGE STAINLESS STEEL FOR MOUNTING AND STRENGTH. PLEASE USE WITH PART #'S AS FOLLOWS: SIZED FOR CAST OUTRIGGER HOLDERS ONLY.

GUNNEL MOUNT

#88502-1 WITH 88502

#88506-1 WITH 88506

SIDE MOUNT

#88505-1 WITH 88505

#88508-1 WITH 88508

WISH BONE HOLDERS



1-1/2" AND 2" LARGE SIDE MOUNT OUTRIGGER HOLDERS

CONSTRUCTED OF HEAVY CAST 316 STAINLESS STEEL WITH 18" POLISHED STAINLESS STEEL TUBE OF 304 SERIES STAINLESS. AVAILABLE IN EITHER 1-1/2" ID TUBE OR 1-7/8" ID TUBE.

#88510 – 2" OD AND 1-7/8" ID TUBE

#88511 – 1-5/8" OD AND 1-1/2" ID TUBE

CENTER RIGGER CLAMP-ON HOLDER



#88150 - CLAMP-ON CENTER RIGGER HOLDER 1" (1.315) IPS PIPE CLAMP WITH 1 1/8" HOLDER

ALUMINUM EXTRUSIONS & T-TOP BACKING PLATES



#88920 – 20" X 4.25" X .50" ALUMINUM EXTRUSION

#88924 – 24" X 4.25" X .50" ALUMINUM EXTRUSION

(28" & 30" EXTRUSIONS ARE PROUDLY MADE IN USA)

#88928 – 28" X 4.25" X .50" ALUMINUM EXTRUSION

#88930 – 30" X 4.25" X .50" ALUMINUM EXTRUSION

#88932 – 5" X 6.5" X .25" BACKING PLATE

ALL BACKING AND MOUNTING PLATES ARE PRE-DRILLED FOR EASE OF INSTALLATION.



TIGRESS® PROCHOICE OUTRIGGING KITS

THE TIGRESS® LINE OF OUTRIGGER RIGGING KITS FEATURES A GREAT SELECTION OF KITS TO FIT THE NEEDS OF ANY FISHERMAN. WHETHER YOU'VE GOT 15' SKIFF POLES OR 35' DOUBLE RIGGED TOURNAMENT POLES, TIGRESS® HAS A RIGGING KIT FOR YOU. ALL KITS FEATURE TOP QUALITY MATERIALS AND ARE READY TO BE INSTALLED. NOTHING ELSE TO BUY. EACH KIT INCLUDES CLIPS, MOUNTING HARDWARE, CORD, BUNGEEES, GLASS RINGS OR PULLEYS AND SNAPS.



ECONOMY RIGGING KIT

AFFORDABLE KIT DESIGNED FOR SMALL BOAT RIGGERS UP TO 15'. INCLUDES A PAIR OF HIGH IMPACT RELEASE CLIPS, 1-1/4" CORK STOPS, A PAIR OF GLASS RING SNUBBERS, A PAIR OF STAINLESS EYE STRAPS WITH SCREWS AND 75' WHITE NYLON BRAIDED LINE OR 75' OF BLACK NYLON BRAID.

#88600 – WITH WHITE NYLON LINE
#88600-1 – WITH BLACK NYLON LINE



DELUXE RIGGING KIT

FOR SINGLE RIGGED RIGGERS UP TO 20'. KIT INCLUDES 1 PAIR OF PRO RELEASES CLIPS, 1 PAIR OF 1-1/4" CORD STOPS, 1 PAIR OF BLACK BUNGEE CORD WITH GLASS RINGS, 1 PAIR STAINLESS STEEL SCREWS, EYE STRAPS AND 100' OF BLACK NYLON BRAID.

#88601 – WITH BLACK NYLON BRAID
#88602 – WITH 100' OF BLACK 400 POUND MONO AND 4 CRIMPS



ELITE RIGGING KIT

TOP QUALITY KIT INCLUDES 1 PAIR E-Z RELEASE CLIPS, 1 PAIR 1-3/4" CORK BALLS, 1 PAIR BLACK BUNGEE SNUBBERS WITH PULLEY BLOCKS, 1 PAIR STAINLESS EYE STRAPS WITH STAINLESS SCREWS, 4 LEADER SNAPS AND 100' BLACK NYLON BRAIDED LINE. FOR RIGGERS UP TO 22'.

#88603 – WITH BLACK NYLON LINE
#88603-1 – WITH 100' OF 400 POUND BLACK MONO AND 4 CRIMPS



DELUXE PRO RIGGING KIT

THE PRO'S CHOICE. INCLUDES A PAIR OF PRO RELEASE CLIPS, 1 PAIR 1-1/4" CORK STOPS, 1 PAIR OF BLACK SNUBBERS WITH STAINLESS RINGS, 1 PAIR STAINLESS EYE STRAPS WITH STAINLESS SCREWS, 4 LEADER SNAPS AND 100' OF BLACK NYLON BRAIDED LINE. FOR RIGGERS UP TO 22'.

#88602-1 – WITH BLACK NYLON BRAID
#88602-2 – WITH 100' OF BLACK 400 POUND MONO & 4 CRIMPS



TRIPLE KIT

FOR TRIPLE RIGGING YOUR RIGGERS. KIT INCLUDES 3 PAIR E-Z RELEASE CLIPS, 3 PAIR 1-3/4" CORK STOPS, 1 PAIR BLACK SNUBBERS WITH TRIPLE SWIVEL PULLEYS AND STAINLESS STEEL SNAP HOOKS, 1 PAIR OF STAINLESS STEEL EYE STRAPS WITH SCREWS, 300' OF BLACK NYLON BRAIDED LINE AND 12 COAST LOCK LEADER SNAPS. FOR RIGGING UP TO 35'.

#88606 – WITH BRAIDED BLACK NYLON
#88606-1 – WITH 300' OF BLACK 400 LBS. MONO



ULTIMATE RIGGING KIT

FOR DOUBLE RIGGING YOUR RIGGERS. INCLUDES TWO PAIR E-Z RELEASE CLIPS, 2 PAIR 1-3/4" CORK STOPS, 1 PAIR BLACK SNUBBERS WITH DOUBLE STAINLESS STEEL PULLEYS, 1 PAIR STAINLESS STEEL EYE STRAPS WITH STAINLESS SCREWS, 200' BLACK NYLON BRAIDED LINE AND 8 LEADER SNAPS. FOR RIGGERS UP TO 22'.

#88605 – WITH BLACK NYLON BRAID
#88605-1 – WITH 200' OF 400 POUND BLACK MONO



CENTER RIGGER KIT

NEW CENTER RIGGER KIT. INCLUDES 30' OF BLACK NYLON BRAID, 1 GLASS EYE BUNGEE, 1 HIGH IMPACT PLASTIC RELEASE CLIP, 2 COAST LOCK SWIVELS, 1-1/4" CORK STOP AND ONE STAINLESS STEEL PAD EYE WITH STAINLESS SCREWS. FOR RIGGING UP TO 18'.

#88610 – WITH BRAIDED BLACK NYLON



COMPLETE TAGLINE KIT

TAGLINE KIT FEATURES HI-POLISHED 316 STAINLESS STEEL TAG LINE WEIGHT WITH 1/4" RUBBER BUMPER TO PROTECT YOUR BOAT, 35' OF 400 POUND BLACK MONO, CORK STOPS, 316 STAINLESS STEEL SNAPS AND 2 NO. 64 RUBBER BANDS.

#88644 TAG LINE KIT
#88642 TAG LINE WEIGHT

TIGRESS® PROCHOICE SNUBBERS

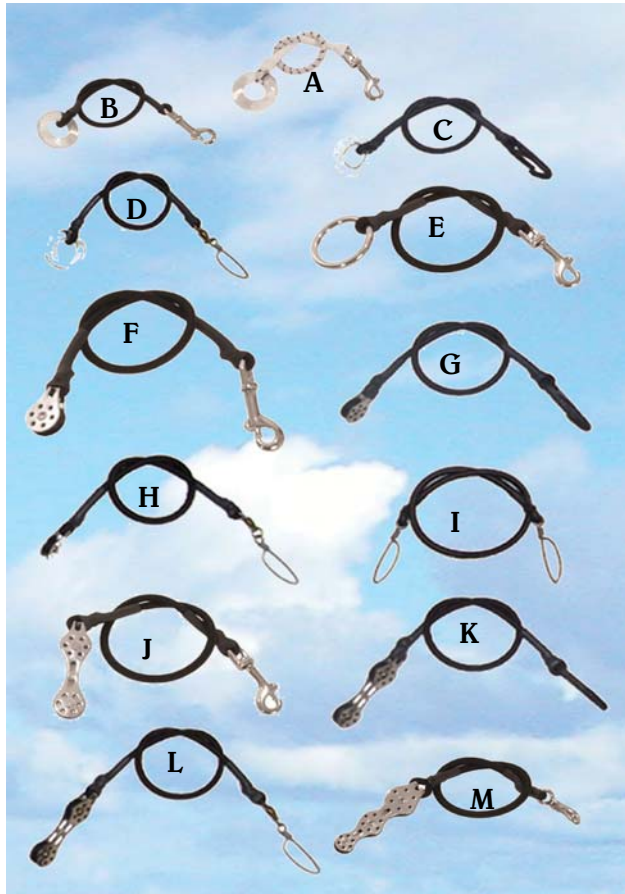

- A #88620 12" ECONOMY SNUBBER
- B #88624 16" DELUXE SNUBBER
#88624-1 6" DELUXE SNUBBER
- C #88624-2 6" DELUXE SNUBBER W/PLASTIC SNAP
#88624-3 12" DELUXE SNUBBER W/PLASTIC SNAP
#88624-4 8" DELUXE SNUBBER W/PLASTIC SNAP
- D #88624-5 6" DELUXE SNUBBER W/BALL BEARING COASTLOCK SWIVEL
#88624-6 12" DELUXE SNUBBER W/BALL BEARING COASTLOCK SWIVEL
#88624-7 18" DELUXE SNUBBER W/BALL BEARING COASTLOCK SWIVEL
- E #88628 16" DELUXE PRO SNUBBER
- F #88632 16" ELITE SNUBBER
#88632-1 6" ELITE SNUBBER
#88632-2 6" ELITE SNUBBER W/PLASTIC SNAP
#88632-3 12" ELITE SNUBBER W/PLASTIC SNAP
#88632-4 18" ELITE SNUBBER W/PLASTIC SNAP
- H #88632-5 6" ELITE SNUBBER W/BALL BEARING COASTLOCK SWIVEL
#88632-6 12" ELITE SNUBBER W/BALL BEARING COASTLOCK SWIVEL
#88632-7 18" ELITE SNUBBER W/BALL BEARING COASTLOCK SWIVEL
- I #88634 16" ELITE PRO SNUBBER W/STAINLESS SNAP
- I #88635 6" EXTENDER SNUBBER
#88635-1 12" EXTENDER SNUBBER
#88635-2 16" EXTENDER SNUBBER
- J #88636 16" ULTIMATE SNUBBER
#88636-1 6" ULTIMATE SNUBBER
- K #88636-2 6" ULTIMATE SNUBBER W/PLASTIC SNAP
#88636-3 12" ULTIMATE SNUBBER W/PLASTIC SNAP
#88636-4 18" ULTIMATE SNUBBER W/PLASTIC SNAP
- L #88636-5 6" ULTIMATE SNUBBER W/BALL BEARING COASTLOCK SWIVEL
#88636-6 12" ULTIMATE SNUBBER W/BALL BEARING COASTLOCK SWIVEL
#88636-7 18" ULTIMATE SNUBBER W/BALL BEARING COASTLOCK SWIVEL
- #88638 16" ULTIMATE PRO SNUBBER W/STAINLESS SNAP
- M #88639 18" TRIPLE SNUBBER W/STAINLESS SNAP

TIGRESS® SNUBBER ACCESSORIES



THE MOST COMPLETE LINE OF OUTRIGGER ACCESSORIES IN THE MARKET PLACE.

- A #88650 PAIR GLASS OUTRIGGER RINGS
- B #88660 PAIR STAINLESS STEEL RINGS
- C #88664 PAIR 316 STAINLESS SNAPS
- D #88666 PAIR NICKEL PLATED SNAPS
- E #88667 PAIR STAINLESS PAD EYES W/STAINLESS SCREWS
- F #88656 PAIR OUTRIGGER RELEASE CLIPS
- G #88695 E-Z OUTRIGGER RELEASE CLIPS (BLACK)
#88696 E-Z OUTRIGGER RELEASE CLIPS (WHITE)
- H #88697 PORTABLE RELEASE CLIP
- I #88657 DOWN RIGGER RELEASE CLIP
- J #88659 FLAT LINE RELEASE CLIP
- K #88630 SINGLE STAINLESS SWIVEL
- L #88640 DOUBLE STAINLESS SWIVEL
- M #88641 TRIPLE STAINLESS SWIVEL
- N #88652 PAIR 1 1/4" CORK STOPS
- O #88654 PAIR 1 3/4" CORK STOPS
- P #88690 PAIR 1 1/4" BLACK PLASTIC STOPS
- Q #88670 100' 400LB. TEST BLACK MONO (DIA. 2.2 MM)
- R #88671 100' 300LB. BLACK NYLON BRAID
#88672 100' 375LB. WHITE NYLON BRAID
- S #88668 ANTENNA FLAG CLIP
- T #88669 HALYARD FLAG CLIP
- U #88673 3/4" OUTRIGGER GUIDE REPLACEMENT (#88220)
#88674 7/8" OUTRIGGER GUIDE REPLACEMENT (#88220)

TIGRESS® KITE ACCESSORIES



#88612 KITE LINE I ASSEMBLY

READY RIGGED KITE LINES COME COMPLETE WITH THREE TIGRESS RELEASE CLIPS ON 250FT. OF 100 LB. SPECTRA LINE WOUND ON A REUSABLE SPOOL AND ARE COMPLETE WITH NECESSARY SWIVELS.

#88613 KITE LINE II ASSEMBLY

READY RIGGED KITE LINES COME COMPLETE WITH TWO TIGRESS RELEASE CLIPS ON 250FT. OF 80 LB. SPECTRA LINE WOUND ON A REUSABLE SPOOL AND ARE COMPLETE WITH NECESSARY SWIVELS.

#88614 KITE LINE III ASSEMBLY

READY RIGGED KITE LINES COME COMPLETE WITH TWO TIGRESS RELEASE CLIPS ON 250FT. OF 50 LB. SPECTRA LINE WOUND ON A REUSABLE SPOOL AND ARE COMPLETE WITH NECESSARY SWIVELS.

#88615 HELIUM BALLOONS

THESE KITE FISHING BALLOONS ARE IDEAL FOR ADDING THAT EXTRA LIFT TO KITES ON THOSE LIGHT WIND DAYS OR USED ON THEIR OWN WHEN THERE IS NO WIND. HIGH QUALITY BALLOONS. 2 PER PACKAGE. WITH THREE CLIPS. MADE OF 100% PURE LATEX. BIODEGRADABLE

#88616 KITE LINE MARKER TAPE

UV RESISTANT KITE LINE TAPE, AN ECONOMICAL CONVENIENT ALTERNATIVE TO WEIGHTED KITE LINE MARKERS.

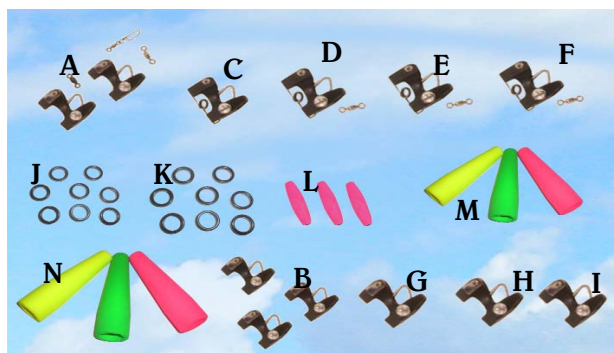

- A. #88655 KITE KIT : (INCLUDES 2 RELEASE CLIPS, 2 WIND-ON SWIVELS & 1 COASTLOCK SWIVEL)
- B. #88655-1 CLIP KITE RELEASE KIT (INCLUDES 3 CLIPS, 3 WIND-ON SWIVELS AND 1 COASTLOCK SWIVEL)
- C. #88658 KITE RELEASE CLIP
- D. #88658-1 KITE CLIP W/SMALL DIAMETER WIRE & WIND-ON SWIVEL
- E. #88658-2 KITE CLIP W/MED DIAMETER WIRE & WIND-ON SWIVEL
- F. #88658-3 KITE CLIP W/LARGE DIAMETER WIRE & WIND-ON SWIVEL
- G. #88658-6 KITE RELEASE CLIP (NO WIRE) SMALL HOLE
- H. #88658-7 KITE RELEASE CLIP (NO WIRE) MEDIUM HOLE
- I. #88658-8 KITE RELEASE CLIP (NO WIRE) LARGE HOLE
- J. #88661 5/16" CERAMIC KITE RINGS (8 EACH)
- K. #88662 1/2" CERAMIC KITE RINGS (8 EACH)
- L. #88962 SMALL KITE LINE MARKERS (3 EACH NOT WEIGHTED)
- M. #88963 MEDIUM WEIGHTED KITE LINE MARKERS (3 EACH)
- N. #88964 LARGE WEIGHTED KITE LINE MARKERS (3 EACH)

ROD HOLDER ARRAY'S

TRIPLE KITE ROD

COLD DRAWN ALUMINUM ANODIZED FOR BEAUTY AND PROTECTION. AVAILABLE IN EITHER BENT BUTT OR STRAIGHT. ROD HOLDER IS USED FOR 1 KITE ROD AND 2 ADDITIONAL RODS TO INCREASE YOUR ROD STORAGE CAPACITY AND KEEP THEM UP AND OUT OF THE WAY. TUBE ID 1 5/8" BASE OD 1.49".

#88156 - BENT BUTT 180 SANDED

GRIT FINISH

#88158 - BENT BUTT VERSION

POLISHED

#88159 - STRAIGHT BUTT VERSION

POLISHED

FIVE BANGER

CONSTRUCTED OF COLD DRAWN HIGH POLISHED ANODIZED ALUMINUM. DESIGNED TO INCREASE YOUR ROD STORAGE CAPACITY FROM 1 TO 5 AND KEEP YOUR FISHING RODS IN EASY REACH. TUBE ID 1 5/8" BASE OD 1.49".

#88157 - STRAIGHT BUTT VERSION

NEW #88157-1 - BENT BUTT VERSION

NEW KITE PRODUCTS

NEW

#88665 KITE RING ASSEMBLY

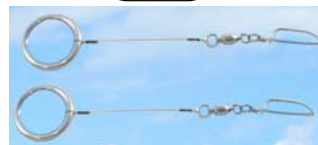

#88658-9 KITE SPRING RELEASE CLIP



#88678 PLANER RELEASE ASSEMBLY

USE WITH PLANER, PROVIDES A QUICK RELEASE AND ALLOWS YOU TO FREE-FIGHT THE FISH. ASSEMBLED WITH 36" OF 480LB TEST CABLE, TIGRESS RELEASE CLIP, H.D. SWIVEL BALL BEARING SNAP SWIVELS.



DUAL KITE ROD

CONSTRUCTED OF COLD DRAWN ANODIZED ALUMINUM. DESIGNED TO INCREASE YOUR ROD STORAGE CAPACITY. OR USE ONE SIDE FOR YOUR KITE ROD AND THE OTHER FOR FISHING ROD. TUBE ID 1 5/8" BASE OD 1.49".

#88154 - STRAIGHT BUTT VERSION
BRUSHED FINISH



HOW TO SET UP YOUR TIGRESS KITE

TIGRESS BY POPULAR DEMAND HAS PUT TOGETHER THE MOST COMPREHENSIVE LINE OF KITE FISHING PRODUCTS AVAILABLE TO THE SPORTS-FISHING INDUSTRY.

FROM A SINGLE HI-PERFORMANCE KITE FOR ALL WINDS FROM 5/25 MILES PER HOUR, TO THE INTRODUCTION THIS YEAR OF OUR NEW HI-VELOCITY KITE TO FLY STEADY IN WINDS OF 15MPH & UP, PRE-RIGGED KITE LINE KITS AND A COMPLETE LINE OF KITE CLIPS AND ACCESSORIES. TIGRESS PROVIDES IT.

DISPLAYED BELOW FOR YOUR USE AND EXPLANATION A SIMPLE DIAGRAM OF A TYPICAL KITE SET UP.

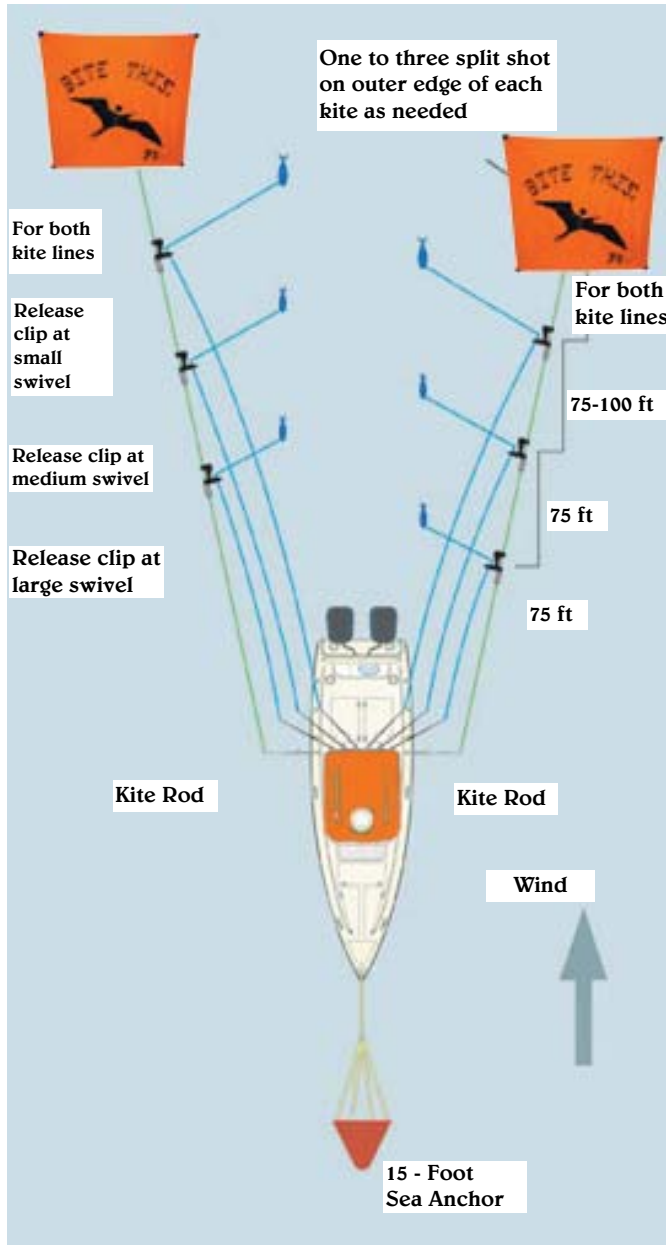

BITE-THIS® HI-PERFORMANCE KITES



#88611 HI-PERFORMANCE BITE THIS® KITE
THE ULTIMATE HIGH PERFORMANCE FISHING KITE. WILL EXCEED ALL OF YOUR EXPECTATIONS AND FLY STEADY IN ALL WINDS FROM 5 - 25 MPH WITH A SIMPLE ADJUSTMENT TO THE BRIDLE, ELIMINATING THE NEED FOR DIFFERENT KITES FOR DIFFERENT WINDS. LIGHT WEIGHT SPARS ARE CONSTRUCTED OF 100% CARBON GRAPHITE.

NEW



#88611-1 HI-VELOCITY BITE THIS® KITE
THIS PARTICULAR KITE MODEL WILL FLY STEADY IN WINDS OF 15 MPH AND UP. DESIGNED SLIGHTLY SMALLER THAN OUR ORIGINAL VERSION. THIS MODEL HAS 4 HOLES IN THE CUSTOM FABRIC BODY TO ALLOW FOR PASSAGE OF AIR THRU THE FACE OF THE KITE ALLOWING IT TO FLY AT HIGHER VELOCITY WINDS THAN OUR ORIGINAL BITE THIS KITE. WE HAVE ALSO INCORPORATED OUR 100% CARBON GRAPHITE STRUTS INTO THE DESIGN OF THIS MODEL THIS MAKING IT THE LIGHTEST AND STRONGEST KITE FRAME IN THE MARKET.

TIGRESS® ROD HOLDERS

PREMIUM ROD HOLDERS



OUR PREMIUM MEDIUM AND LARGE OVAL GUNNEL MOUNT ROD HOLDERS ARE CRAFTED OF 316 STAINLESS AND ARE AVAILABLE IN 30, 15 AND 0 DEGREE. NOW AVAILABLE WITH HEAVY DUTY BASE BAR. BACKING PLATES ALSO AVAILABLE

#88525 – MEDIUM 30° HEAD 3.28" X 4.06", L 9" X 2", ID 1 5/8"
 #88527 – MEDIUM 0° HEAD 3.28" X 4.06", L 9" X 2", ID 1 5/8"
 #88529 – MEDIUM 15° HEAD 3.28" X 4.06", L 9" X 2", ID 1 5/8"
 #88530 – LARGE 30° HEAD 3.85" X 4.88", L 10 1/2" X 2-1/4", ID 1 7/8"
 #88532 – LARGE 0° HEAD 3.85" X 4.88", L 10 1/2" X 2-1/4", ID 1 7/8"
 #88534 – LARGE 15° HEAD 3.85" X 4.88", L 10 1/2" X 2-1/4", ID 1 7/8"

PIVOTING ROD HOLDERS



LARGE PIVOTING OVAL GUNNEL MOUNT ROD HOLDERS DESIGNED TO BE USED PRIMARILY WITH BENT BUTT TACKLE. PIVOTING BASE ALLOW THE ROD HOLDER TO ROTATE IN THE ROD HOLDER WHEN SIDE PRESSURE IS APPLIED TO THE TIP OF THE ROD, TO BETTER CONTROL THE FISH.

#88520 – 30° HEAD 3.85" X 4.88", L 10-1/2" X 2-1/4", ID 1 7/8"
 #88522 – 0° HEAD 3.85" X 4.88", L 10-1/2" X 2-1/4", ID 1 7/8"
 #88524 – 15° HEAD 3.85" X 4.88", L 10-1/2" X 2-1/4", ID 1 7/8"
4 HOLE EXTRA LONG PIVOTING RECTANGULAR HEAD STYLE
 #88520XL – 30° HEAD 4.25" X 4.75", L 12 1/2" X 2 1/4", ID 1 7/8"
 #88522XL – 0° HEAD 4.25" X 4.75", L 12 1/2" X 2 1/4", ID 1 7/8"
 #88524XL – 15° HEAD 4.25" X 4.75", L 12 1/2" X 2 1/4", ID 1 7/8"

SIDE MOUNT ROD HOLDERS



TIGRESS 316 STAINLESS STEEL 9" SIDE MOUNT OR SWIVEL MOUNT ROD HOLDERS

DESIGNED FOR APPLICATIONS WHERE CLAMP-ON OR FLUSH MOUNT HOLDERS ARE NOT PRACTICAL. CAN BE MOUNTED ON ANY VERTICAL FLAT SURFACE. WHITE VINYL INSERT INCLUDED TO PROTECT YOUR ROD.

#88540 - 9" X 1 5/8" ID SIDE MOUNT ROD HOLDER
 #88542 - 9" X 1 5/8" ID PIVOTING SIDE MOUNT ROD HOLDER

IF USING OTHER THAN 0°, MUST BE CUT TO DEGREE FOR PROPER USE.

- #88176-2 - 88176 ADJUSTABLE
- #88180-2 - 88180 SERIES
- #88530-2 - 88520 & 88530 SERIES
- #88152-1 FLARED WELD-ON
- #88152-2 OFFSHORE FLARED WELD-ON CUT TO DEGREE.
- #77900-3 BLACK 30° 9"
- #77901-3 BLACK 0° 9"
- #77902-3 BLACK 15° 9"
- #77900-4 WHITE 30° 9"
- #77901-4 WHITE 0° 9"
- #77902-4 WHITE 15° 9"

VINYL INSERTS



STAINLESS STEEL GIMBALS

MAXIMUM STRENGTH AND BUILT TO WITHSTAND THE RIGORS OF OFFSHORE FISHING!

#88550 – FLAT CHAIR GIMBAL CRAFTED FROM POLISHED STAINLESS STEEL
 #88552 – TUBULAR CHAIR GIMBAL CRAFTED FROM POLISHED STAINLESS STEEL
 #105550 - SWIVEL GIMBAL (316 SS)



TIGRESS® LARGE ROD HOLDER EXTENDERS & SWIVEL ADAPTER

USE OUR STAINLESS & NYLON ROD HOLDER EXTENDERS TO SHORTEN YOUR ROD HOLDER TO FIT YOUR BENT BUTT FISHING ROD. AVAILABLE IN 2", 4" & 6". ALSO WE OFFER OUR STAINLESS STEEL SWIVEL ADAPTER TO CONVERT YOUR STANDARD ROD HOLDER TO A SWIVEL ROD HOLDER. FITS MOST MEDIUM & LARGE ROD HOLDERS.

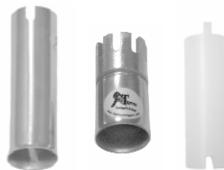

- #88686 6" STAINLESS STEEL ROD HOLDER EXTENDER
- #88686-1 4" STAINLESS STEEL ROD HOLDER EXTENDER
- #88686-2 2" STAINLESS STEEL ROD HOLDER EXTENDER
- #88688 6" NYLON ROD HOLDER EXTENDER
- #88688-1 4" NYLON ROD HOLDER EXTENDER
- #88688-2 2" NYLON ROD HOLDER EXTENDER
- #88687 STAINLESS STEEL SWIVEL ROD HOLDER ADAPTER

**ROD HOLDERS MIRROR
POLISHED 316 STAINLESS**

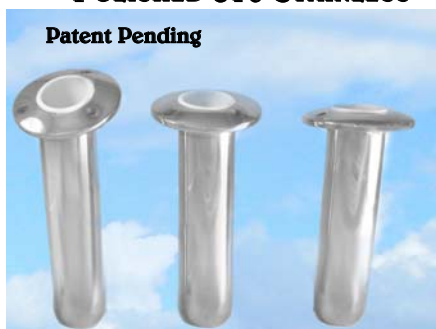

**TIGRESS® GUNNEL MOUNT ROD HOLDERS
ROUND HEAD CLOSED BASE**

HEAVY DUTY ROUND HEAD CLOSED END BASE, WITH DRAIN HOLE TO ACCEPT 1/4" NPT PIPE TO HOSE FITTING #77910 FOR DIRECTING WATER TO THE BILGE. USE BACKING PLATES #77900-2. ROD HOLDERS AVAILABLE WITH EITHER WHITE OR BLACK LINERS. REQUIRES 1/4 X 20 MACHINE BOLTS NOT INCLUDED.

- #77900 - MEDIUM 30° HEAD 3.28" L 9" X 2", ID 1 5/8"
- #77901 - MEDIUM 15° HEAD 3.28" L 9" X 2", ID 1 5/8"
- #77902 - MEDIUM 0° HEAD 3.28" L 9" X 2", ID 1 5/8"
- #77906 - LARGE 30° HEAD 4.08 L 10 1/2" X 2 1/2" ID 1 7/8"
- #77907 - LARGE 15° HEAD 4.08 L 10 1/2" X 2 1/2" ID 1 7/8"
- #77908 - LARGE 0° HEAD 4.08 L 10 1/2" X 2 1/2" ID 1 7/8"



BLIND ROUND HEAD CLOSED BASE

ELIMINATE FASTENING FROM THE TOP OF FLANGE AND ENHANCE THE LOOK OF YOUR GUNNEL. CLOSED BOTTOM ALLOWS FOR USE OF DRAIN PLUG #77910 FOR DIRECTING WATER TO THE BILGE. USE BACKING PLATES #77900-2. AVAILABLE WITH BLACK OR WHITE LINERS. REQUIRES 1/4 X 20 MACHINE BOLTS NOT INCLUDED.

- #77900-1 - MEDIUM 30° HEAD 3.28" L 9" X 2", ID 1 5/8"
- #77901-1 - MEDIUM 15° HEAD 3.28" L 9" X 2", ID 1 5/8"
- #77902-1 - MEDIUM 0° HEAD 3.28" L 9" X 2", ID 1 5/8"



BLIND ROUND HEAD SWIVEL BASE

ELIMINATE FASTENING FROM THE TOP OF FLANGE AND ENHANCES THE LOOK OF YOUR GUNNEL. SWIVEL BASE IS DESIGNED TO BE USED PRIMARILY WITH BENT BUTT TACKLE, THIS ALLOWING THE ROD HOLDER TO ROTATE IN THE ROD HOLDER WHEN SIDE PRESSURE IS APPLIED TO THE TIP OF THE ROD, AND FOR BETTER CONTROL THE FISH. USE BACKING PLATES #77900-2. AVAILABLE WITH WHITE OR BLACK LINERS. REQUIRES 1/4 X 20 MACHINE BOLTS NOT INCLUDED.

- #77903 - MEDIUM 30° HEAD 3.28" L 9" X 2", ID 1 5/8"
- #77904 - MEDIUM 15° HEAD 3.28" L 9" X 2", ID 1 5/8"
- #77905 - MEDIUM 0° HEAD 3.28" L 9" X 2", ID 1 5/8"



BLIND OVAL HEAD CLOSED BASE

ELIMINATE FASTENING FROM THE TOP OF FLANGE AND ENHANCE THE LOOK OF YOUR GUNNEL. CLOSED BOTTOM ALLOWS FOR USE OF DRAIN PLUG 77910 FOR DIRECTING WATER TO THE BILGE. USE BACKING PLATES #88525-2. AVAILABLE WITH WHITE OR BLACK LINERS. REQUIRES 1/4 X 20 MACHINE BOLTS NOT INCLUDED.

- #88535-1 - MEDIUM 30° HEAD 3.28" X 4.06", L 9" X 2", ID 1 5/8"
- #88537-1 - MEDIUM 0° HEAD 3.28" X 4.06", L 9" X 2", ID 1 5/8"
- #88539-1 - MEDIUM 15° HEAD 3.28" X 4.06", L 9" X 2", ID 1 5/8"



OVAL HEAD CLOSED BASE

HEAVY DUTY CLOSED END BASE WITH DRAIN HOLE TO ACCEPT 1/4" NPT PIPE TO HOSE FITTING (#77910) FOR DIRECTING WATER TO THE BILGE. USE BACKING PLATES #88525-5. AVAILABLE WITH EITHER WHITE OR BLACK LINERS. REQUIRES 1/4 X 20 MACHINE BOLTS NOT INCLUDED.

- #88535 - MEDIUM 30° HEAD 3.28" X 4.06", L 9" X 2", ID 1 5/8"
- #88537 - MEDIUM 0° HEAD 3.28" X 4.06", L 9" X 2", ID 1 5/8"
- #88539 - MEDIUM 15° HEAD 3.28" X 4.06", L 9" X 2", ID 1 5/8"



TIGRESS® ROD HOLDER ACCESSORIES & TIGRESS BITE THIS BAT



STAINLESS STEEL ROD HOLDER BACKING PLATES (BACKING PLATES FIT ALL ANGLES)

#77900-2 - ROUND HEAD ROD HOLDER BACKING PLATE

#88525-1 - MEDIUM ROD HOLDER BACKING PLATE

#88530-1 - LARGE ROD HOLDER BACKING PLATE

#88521 - EXTRA LONG ROD HOLDER BACKING PLATE

#77910 - 316 STAINLESS PIPE TO HOSE FITTING 1/4" NPT

#88675 - 10' SAFETY STRAP (PAIR)

#88676 - T-TOP ROD SAFETY STRAP (4 EACH)

SAFETY STRAPS ARE DESIGNED TO KEEP YOUR RODS AND REELS FROM BOUNCING OUT OF THEIR HOLDERS, ELIMINATING THE POSSIBILITY OF LOSING THEM OVERBOARD. STRAPS HOLD THE ROD INTO THE ROD HOLDER ON YOUR TUNA TOWER, ROCKET LAUNCHER OR T-TOP.

#88682 TIGER FISH BAT : 18" ALL ALUMINUM CONSTRUCTION WITH SOFT EVA FOAM GRIP.

ALUMINUM TAPERED STYLE CLAMP-ON ROD HOLDERS

TAPERED STYLE CLAMP-ON ROD HOLDERS, CONSTRUCTED OF MARINE GRADE COLD DRAWN ALUMINUM, 100% ANODIZED AFTER FABRICATION FOR BEAUTY AND PROTECTION. EACH INCLUDES A HEAVY WHITE VINYL LINER. AVAILABLE IN EITHER SILVER OR GOLD ANODIZED. TUBE ID 1.66".

HORIZONTAL MOUNT

#88160 - *3/4" SILVER, 1.05 ID CLAMP

#88160-1 *3/4" GOLD, 1.05 ID CLAMP

#88162 - *1" SILVER, 1.32 ID CLAMP

#88162-1 *1" GOLD, 1.32 ID CLAMP

#88164 - *1-1/4" SILVER, 1.66 ID CLAMP

#88164-1 *1 1/4" SILVER, 1.66 ID CLAMP

VERTICAL MOUNT

#88161 - *3/4" SILVER, 1.05 ID CLAMP

#88161-1 *3/4" GOLD, 1.05 ID CLAMP

#88163 - *1" SILVER, 1.32 ID CLAMP

#88163-1 *1" GOLD, 1.32 ID CLAMP

#88165 - *1-1/4" SILVER, 1.66 ID CLAMP

#88165-1 *1 1/4" GOLD, 1.66 ID CLAMP

*SIZED FOR SCHEDULE PIPE SIZE - IF PLACING ON TUBE, REDUCE SIZE BY 1/4"

316 STAINLESS STEEL CLAMP-ON ROD HOLDERS

AN ATTRACTIVE TAPERED STYLE TUBE IS FABRICATED TO A FIXED CLAMP CONSTRUCTED OF 316 STAINLESS STEEL IN HORIZONTAL OR VERTICAL MOUNTING. AVAILABLE IN HIGH POLISH STAINLESS STEEL OR GOLD TITANIUM FINISH WITH HEAVY DUTY WHITE VINYL LINER FOR ROD PROTECTION. ALL CLAMP-ON ROD HOLDERS ARE SIZED FOR ALUMINUM PIPE WHICH IS DIFFERENT FROM STANDARD STAINLESS TUBE. TUBE ID 1.66".

HORIZONTAL MOUNT

#88180 - *3/4" SILVER, 1.05 ID CLAMP

#88180-1 *3/4" GOLD, 1.05 ID CLAMP

#88182 - *1" SILVER, 1.32 ID CLAMP

#88182-1 *1" GOLD, 1.32 ID CLAMP

#88184 - *1 1/4" SILVER, 1.66 ID CLAMP

#88184-1 *1 1/4" GOLD, 1.66 ID CLAMP

#88186 - *1 1/2" SILVER, 1.90 ID CLAMP

#88186-1 *1 1/2" GOLD, 1.90 ID CLAMP

#88188 - *2" SILVER, 2.38 ID CLAMP

#88188-1 *2" GOLD, 2.38 ID CLAMP

VERTICAL MOUNT

#88181 - *3/4" SILVER, 1.05 ID CLAMP

#88181-1 *3/4" GOLD, 1.05 ID CLAMP

#88183 - *1" SILVER, 1.32 ID CLAMP

#88183-1 *1" GOLD, 1.32 ID CLAMP

#88185 - *1 1/4" SILVER, 1.66 ID CLAMP

#88185-1 *1 1/4" GOLD, 1.66 ID CLAMP

#88187 - *1 1/2" SILVER, 1.90 ID CLAMP

#88187-1 *1 1/2" GOLD, 1.90 ID CLAMP

#88189 - *2" SILVER, 2.38 ID CLAMP

#88189-1 *2" GOLD, 2.38 ID CLAMP

*SIZED FOR SCHEDULE PIPE SIZE - IF PLACING ON TUBE, REDUCE SIZE BY 1/4"

316 STAINLESS STEEL ADJUSTABLE CLAMP-ON ROD HOLDERS

OUR NEW ADJUSTABLE MOUNT STAINLESS STEEL CLAMP-ON ROD HOLDER ALLOWS YOU TO CHOOSE THE ANGLE YOU NEED WHILE PROVIDING THE VERSATILITY OF MOUNTING EITHER HORIZONTALLY OR VERTICALLY, AS YOU REQUIRE. AVAILABLE IN POLISHED STAINLESS FINISH OR WITH OUR HIGH-TECH GOLD TITANIUM PLATING, FOR YEARS OF SERVICE. TUBE ID 1.66".

#88190 - *3/4" SILVER, 1.05 ID CLAMP

#88190-1 *3/4" GOLD, 1.05 ID CLAMP

#88191 - *1" SILVER, 1.32 ID CLAMP

#88191-1 *1" GOLD, 1.32 ID CLAMP

#88192 - *1-1/4" SILVER, 1.66 ID CLAMP

#88192-1 *1 1/4" GOLD, 1.66 ID CLAMP

#88193 - *1-1/2" SILVER, 1.90 ID CLAMP

#88193-1 *1 1/2" GOLD, 1.90 ID CLAMP

#88194 - *2" SILVER, 2.38 ID CLAMP

#88194-1 *2" GOLD, 2.38 ID CLAMP

CLAMPS ARE SIZED FOR SCHEDULE PIPE. *SCHEDULE PIPE SIZE - IF PLACING ON TUBE, REDUCE SIZE BY 1/4"

HOW TO MEASURE SCHEDULE PIPE IPS (CONFIRM YOUR TUBE SIZE BEFORE PURCHASE)

IPS Pipe Size	Pipe Size #	Pipe O.D.	Pipe Circumference
3/4"	#1	1-1/16"	3-5/16"
1"	#2	1-5/16"	4-1/8"
1-1/4"	#3	1-21/23"	5-7/32"
1-1/2"	#4	1-7/8"	5-31/32"

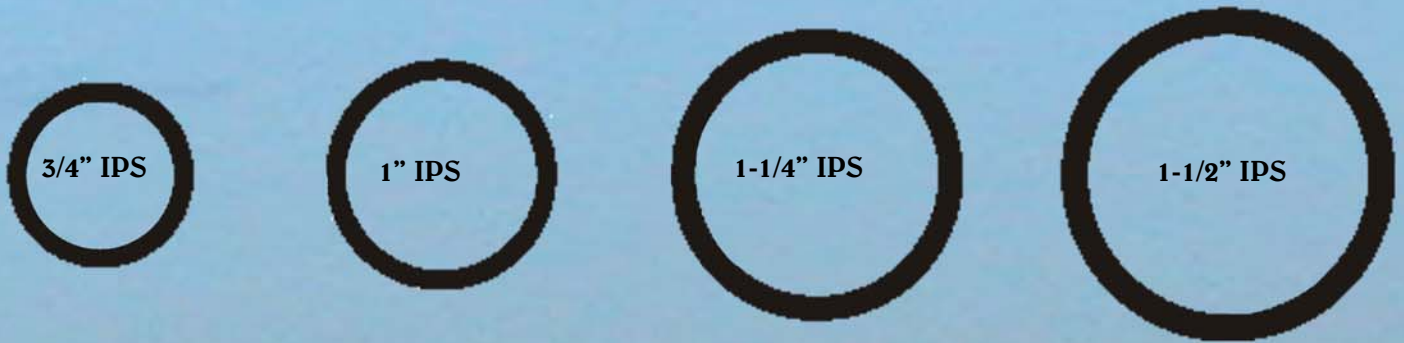
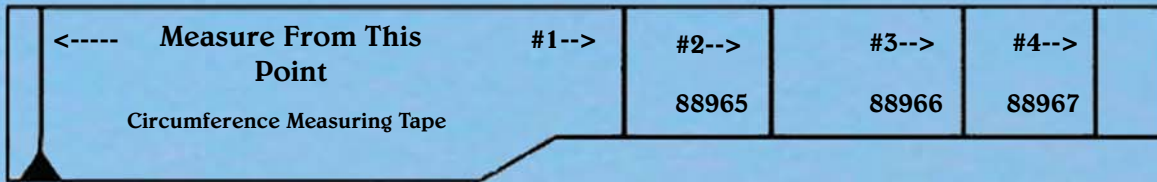

PLEASE USE THE ABOVE TAPES TO MEASURE YOUR CLAMP-ON ROD HOLDERS, CLAMP-ON OUTRIGGER HOLDERS, CENTER RIGGER HOLDERS, AND OUR NEW LED CLAMP-ON LIGHTS BEFORE PURCHASE.

TIGRESS® CLAMP-ON ROD HOLDER & ANTENNA MOUNT

3/4" - 1" ADJUSTABLE CLAMP ON ROD HOLDER

OUR IMPROVED VERSION OF THE OLD STANDARD RAIL MOUNT ROD HOLDER. FEATURES ALL 316 STAINLESS STEEL CLAMP MECHANISM WITH HIGH POLISHED STAINLESS TUBE AND WHITE VINYL LINER FOR ROD PROTECTION. FITS 3/4" AND 1" RAILS. L 9" X 2" OD. TUBE ID 1 5/8". #88176



EXTRA HEAVY DUTY CONSTRUCTION FOR BIG ANTENNA'S AND TOUGH CONDITIONS

HEAVY DUTY ANTENNA BASE WITH FOUR WAY RATCHET DESIGNED FOR DECK AND SIDE MOUNTING. FEATURES HEAVY DUTY STAINLESS STEEL CONSTRUCTION AND QUICK ACTION HANDLE FOR RAISING AND LOWERING YOUR ANTENNA. SUITABLE FOR ALL MARINE APPLICATIONS HARD TOPS, T-TOPS AND RADAR ARCHES. 9/32" HOLE FOR CABLE FEED AND STANDARD 1"-14 THREADS FOR ATTACHMENT OF ANTENNA. #66230

SEATIGER "ECONOMY" STAINLESS STEEL ROD HOLDERS

CRAFTED AS A MORE ECONOMICAL ALTERNATIVE TO OUR PREMIUM ROD HOLDERS. FOR THE BUDGET-MINDED FISHERMAN, OUR SEATIGER FLUSH MOUNT ROD HOLDERS ARE AVAILABLE WITH EITHER A STAMPED MOUNTING FLANGE OR CAST STAINLESS STEEL FLANGE. FOR DURABILITY AND LOOKS. THE ROD RIGGER, SIDE MOUNT ROD HOLDER AND REMOVABLE ROD HOLDER ARE ALL STAINLESS STEEL CONSTRUCTION POLISHED TO A HIGH LUSTER.



77170

77171

77172

77174

77177

77178

77179

77173

#77170 - 30° - 9" x 1 5/8" ID STAMPED OVAL ROD HOLDER (FLIP TOP)

#77171 - 30° - 9" x 1 5/8" ID STAMPED ROD HOLDER (FLIP TOP)

#77172 - 30° - 9" x 1 5/8" ID CAST OVAL ROD HOLDER (FLIP TOP)

#77173 - STAINLESS ROD RIGGER (TUBE 16.5")

#77174 - 30° - 9" x 1 5/8" ID CAST ROD HOLDER (OPEN TOP)

#77177 - REMOVABLE ROD HOLDER, INCLUDES MOUNTING BRACKET (9" x 1 5/8" ID)

#77178 - REPLACEMENT MOUNTING BRACKET (H 4" x W 3.61")

#77179 - SIDE MOUNT ROD HOLDER (9" x 1 5/8" ID)

TIGRESS® PREMIUM REEL HANGERS

GOLD ANODIZED SPRING LOADED BRACKET HOLDS REEL IN HARNESS LUGS. ROD TIP END ROTATES TO LOCK IN THE ROD AND STORE IT UP AND OUT OF THE WAY. AVAILABLE FOR MOST PENN AND SHIMANO REELS.



#88700 - 12T, 12LT, 16S PENN, 16LT, TTS 50 SHIMANO, 4/0-6/0 FINOR (2.158)

#88701 - 20T PENN (1.468)

#88702 - 30T PENN, 30S (2.076)

#88703 - 30TW, 30SW, 30STW PENN, TLD 50 SHIMANO, VSW30 (2.823)

#88704 - 50T, 50S PENN (2.338)

#88705 - 50TW, 50SW, 50STW PENN, 80 PENN, 70S PENN, 9/0 FINOR VSW50 (3.163)

#88706 - 4/0 PENN SENATOR, 7.5/0 FINOR, TBM 30/50 SHIMANO (2.438)

#88707 - 80T, 80ST, 80TS PENN (3.323)

#88708 - 80TW, 80SW, 80STW PENN, DUEL 9/0 (4.068)

#88709 - 130ST PENN, AHAB 50 ORIGINAL FINOR (3.813)

#88710 - 30W TIAGRA (3.603)

#88711 - 50 TIAGRA (2.891)

#88712 - 50WLRS TIAGRA, 50W, 130H/S PENN, TBM 80/130 SHIMANO (3.678)

#88713 - 80W TIAGRA (4.387)

#88714 - 130 TIAGRA (4.308)

#88715 - TLD 25/30 II SHIMANO (2.213)

#88716 - 70 VS PENN (3.160)

#88717 - TLD 20 SHIMANO (1.673)

#88718 - 20 SHIMANO (1.806)

#88719 - 30 TIAGRA (2.345)

#88720 - 12 TIAGRA (1.532)

#88721 - 16 TIAGRA (2.262)

#88722 - PENN SENATOR 6/0 (114H) (2.624)

#88723 - PENN SENATOR 9/0 10/0 (3.250)

#88725 - ADJUSTABLE REEL HANGER (ONE SIZE FITS MOST REELS)

TIGRESS® PREMIUM ROD HANGERS

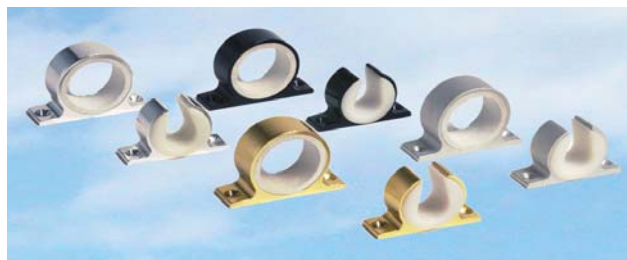

TO ACCOMMODATE HANGING YOUR RODS UP AND OUT OF THE WAY WITH THE ROD BUTT AND TIP. ROD HANGERS AVAILABLE IN ANODIZED ALUMINUM, SILVER, GOLD, BLACK AND POLISHED STAINLESS STEEL. DEMS: CLOSED END = 1.55" AND OPEN END = .60".

- #88544 – SILVER ANODIZED
- #88545 – GOLD
- #88546 – BLACK
- #88547 – 316 POLISHED STAINLESS STEEL

TIGRESS® PREMIUM HAND GAFFS



OUR HAND GAFFS BY TIGRESS® ARE CONSTRUCTED OF COLD DRAWN ALUMINUM SHAFTS WITH HI-POLISHED STAINLESS STEEL HOOKS AND ARE FITTED WITH SOFT BLACK EVA FOAM GRIPS.

- #88330 - 2" HOOK WITH GOLD COLLAR
- #88332 - 2" HOOK WITH BLACK COLLAR
- #88334 - 3" HOOK WITH GOLD COLLAR
- #88336 - 3" HOOK WITH BLACK COLLAR
- #88338 - 4" HOOK WITH GOLD COLLAR
- #88340 - 4" HOOK WITH BLACK COLLAR
- #88342 - 5" HOOK WITH GOLD COLLAR
- #88344 - 5" HOOK WITH BLACK COLLAR



TIGRESS® PREMIUM GAFFS

OUR GAFFS BY TIGRESS® ARE CONSTRUCTED OF COLD DRAWN ALUMINUM SHAFTS WITH HI-POLISHED STAINLESS STEEL HOOKS AND FITTED WITH SOFT BLACK EVA FOAM GRIPS. THESE GAFFS ARE STRONG, LIGHTWEIGHT AND ARE AVAILABLE IN EITHER BLACK ANODIZED WITH ANODIZED GOLD TRIM OR SILVER ANODIZED WITH GOLD TRIM. FOR LASTING BEAUTY AND CORROSION RESISTANCE. AVAILABLE IN 16 SIZES IN LENGTHS OF 3', 4', 6' AND 8' WITH HOOK SIZES OF 2", 3", 4" AND 5".

- | | | |
|--------------------------------|--------------------------------|--------------------------------|
| #88385 - 2" X 3' BLACK & GOLD | #88364 - 3" X 3' SILVER & GOLD | #88374 - 4" X 6' BLACK & GOLD |
| #88386 - 2" X 3' SILVER & GOLD | #88366 - 3" X 4' BLACK & GOLD | #88376 - 4" X 6' SILVER & GOLD |
| #88350 - 2" X 4' BLACK & GOLD | #88368 - 3" X 4' SILVER & GOLD | #88378 - 4" X 8' BLACK & GOLD |
| #88352 - 2" X 4' SILVER & GOLD | #88393 - 3" X 5' BLACK & GOLD | #88380 - 4" X 8' SILVER & GOLD |
| #88391 - 2" X 5' BLACK & GOLD | #88394 - 3" X 5' SILVER & GOLD | #88389 - 5" X 4' BLACK & GOLD |
| #88392 - 2" X 5' SILVER & GOLD | #88387 - 4" X 3' BLACK & GOLD | #88390 - 5" X 4' SILVER & GOLD |
| #88354 - 2" X 6' BLACK & GOLD | #88388 - 4" X 3' SILVER & GOLD | #88397 - 5" X 5' BLACK & GOLD |
| #88356 - 2" X 6' SILVER & GOLD | #88370 - 4" X 4' BLACK & GOLD | #88398 - 5" X 5' SILVER & GOLD |
| #88358 - 2" X 8' BLACK & GOLD | #88372 - 4" X 4' SILVER & GOLD | #88382 - 5" X 6' BLACK & GOLD |
| #88360 - 2" X 8' SILVER & GOLD | #88395 - 4" X 5' BLACK & GOLD | #88384 - 5" X 6' SILVER & GOLD |
| #88362 - 3" X 3' BLACK & GOLD | #88396 - 4" X 5' SILVER & GOLD | |

HOOK DIAMETERS:
 2" MODELS – 1/4"
 3" MODELS – 5/16"
 4" MODELS – 3/8"
 5" MODELS – 1/2"

TIGRESS® HEAVY DUTY BEARING STYLE HINGES300 SERIES HI-POLISHED



3", 4", 5", AND 6" HAVE UNIQUE BALL BEARING ASSEMBLY INCORPORATED INTO PIN FOR EASY OPENING AND CLOSING.

- | | |
|--------------------------|------------------|
| #21178 - 1-1/2" X 1-1/2" | #21188 - 4" X 4" |
| #21180 - 2" X 2" | #21192 - 5" X 5" |
| #21184 - 3" X 3" | #21196 - 6" X 6" |

(1-1/2" AND 2" ARE STANDARD WITH NO BALL BEARINGS)

TIGRESS® HEAVY DUTY HI-POLISHED STAINLESS WELD-ON ROD HOLDER



- #88155 - 316 STAINLESS STEEL WELD-ON ROD HOLDER 10 1/2" TAPERED.

WEDGES AVAILABLE
IN 3/8" THICKNESS

COLORS AVAILABLE

GL = BRIGHT GOLD SL = BRIGHT SILVER
BG = BRUSHED GOLD BS = BRUSHED SILVER

ALUMINUM WELD ON LONG WEDGE



STANDARD CLASS (1 7/8")

- #66100 - WOL 8.5"- GL
- #66101 - WOL 8.5"- BG
- #66102 - WOL 8.5"- SL
- #66103 - WOL 8.5"- BS

OFFSHORE CLASS (2 1/8")

- #66130 - WOLB 10"- GL
- #66131 - WOLB 10"- BG
- #66132 - WOLB 10"- SL
- #66133 - WOLB 10"- BS

- #66120 - WOL 10"- GL
- #66121 - WOL 10"- BG
- #66122 - WOL 10"- SL
- #66123 - WOL 10"- BS

LONG WEDGE EURO STYLE



STANDARD CLASS (1 7/8")

- #66141 - LWST 8.5"- GL
- #66142 - LWST 8.5"- BG
- #66143 - LWST 8.5"- SL
- #66144 - LWST 8.5"- BS

OFFSHORE CLASS (2 1/8")

- #66160 - LWSTB 10"- GL
- #66161 - LWSTB 10"- BG
- #66162 - LWSTB 10"- SL
- #66163 - LWSTB 10"- BS

- #66150 - LWST 10"- GL
- #66151 - LWST 10"- BG
- #66152 - LWST 10"- SL
- #66153 - LWST 10"- BS

ALUMINUM WELD ON SHORT WEDGE



STANDARD CLASS (1 7/8")

HOLE IN WEDGE

- #66200 - WOT 8.5"- GL
- #66201 - WOT 8.5"- BG
- #66202 - WOT 8.5"- SL
- #66203 - WOT 8.5"- BS

STANDARD CLASS (1 7/8")

NO HOLE IN WEDGE

- #66220 - WOPE 8.5"- GL
- #66221 - WOPE 8.5"- BG
- #66222 - WOPE 8.5"- SL
- #66223 - WOPE 8.5"- BS

- #66210 - WOT 10"- GL
- #66211 - WOT 10"- BG
- #66212 - WOT 10"- SL
- #66213 - WOT 10"- BS

- #66240 - WOPE 10"- GL
- #66241 - WOPE 10"- BG
- #66242 - WOPE 10"- SL
- #66243 - WOPE 10"- BS

COLORS AVAILABLE

GL = BRIGHT GOLD
BG = BRUSHED GOLD

SL = BRIGHT SILVER
BS = BRUSHED SILVER

WEDGES AVAILABLE
IN 3/8" THICKNESS

SHORT WEDGE EURO STYLE



STANDARD CLASS (1 7/8")

- #66250 - TWST 8.5"- GL
- #66251 - TWST 8.5"- BG
- #66252 - TWST 8.5"- SL
- #66253 - TWST 8.5"- BS

- #66260 - TWST 10"- GL
- #66261 - TWST 10"- BG
- #66262 - TWST 10"- SL
- #66263 - TWST 10"- BS

OFFSHORE CLASS (2 1/8")

- #66270 - TWSTB 10"- GL
- #66271 - TWSTB 10"- BG
- #66272 - TWSTB 10"- SL
- #66273 - TWSTB 10"- BS

ALUMINUM WELD ON TUBE ROD HOLDERS

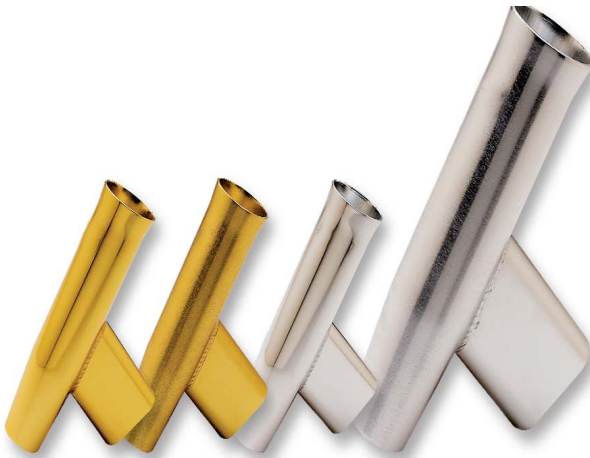

STANDARD CLASS (1 7/8")

TUBE 5" L x 1 7/8" WIDE

- #66300 - WOO 10"- GL
- #66301 - WOO 10"- BG
- #66302 - WOO 10"- SL
- #66303 - WOO 10"- BS

OFFSHORE CLASS (2 1/8")

TUBE 7" L x 3" WIDE

- #66310 - WOOLB 10"- GL
- #66311 - WOOLB 10"- BG
- #66312 - WOOLB 10"- SL
- #66313 - WOOLB 10"- BS

TUBE 5" L x 3" WIDE

- #66320 - WOOB 10"- GL
- #66321 - WOOB 10"- BG
- #66322 - WOOB 10"- SL
- #66323 - WOOB 10"- BS

TUBE ROD HOLDER EURO STYLE



STANDARD CLASS (1 7/8")

ROUND TUBE (1 1/4")

- #66330 - WORST 10"- GL
- #66331 - WORST 10"- BG
- #66332 - WORST 10"- SL
- #66333 - WORST 10"- BS

- #66340 - WOOST 10"- GL
- #66341 - WOOST 10"- BG
- #66342 - WOOST 10"- SL
- #66343 - WOOST 10"- BS

OFFSHORE CLASS (2 1/8")

OVAL TUBE (5"L x 1 7/8"W)

- #66350 - WORSTB 10"- GL
- #66351 - WORSTB 10"- BG
- #66352 - WORSTB 10"- SL
- #66353 - WORSTB 10"- BS

- #66360 - WOOSTB 10"- GL
- #66361 - WOOSTB 10"- BG
- #66362 - WOOSTB 10"- SL
- #66363 - WOOSTB 10"- BS

ALUMINUM PLAIN ROD HOLDER

COLORS AVAILABLE

EURO STYLE

GL = BRIGHT GOLD
SL = BRIGHT SILVER

BG = BRUSHED GOLD
BS = BRUSHED SILVER



STANDARD CLASS (1 7/8" ID)

#66400 - WOP 8.5" - GL

#66401 - WOP 8.5" - BG

#66402 - WOP 8.5" - SL

#66403 - WOP 8.5" - BS

#66410 - WOP 10" - GL

#66411 - WOP 10" - BG

#66412 - WOP 10" - SL

#66413 - WOP 10" - BS

OFFSHORE CLASS (2 1/8" ID)

#66420 - WOPB 10" - GL

#66421 - WOPB 10" - BG

#66422 - WOPB 10" - SL

#66423 - WOPB 10" - BS

EURO STYLE (1 7/8")

#66430 - WOPST 8.5" - GL

#66431 - WOPST 8.5" - BG

#66432 - WOPST 8.5" - SL

#66433 - WOPST 8.5" - BS

#66440 - WOPST 10" - GL

#66441 - WOPST 10" - BG

#66442 - WOPST 10" - SL

#66443 - WOPST 10" - BS

ALUMINUM WALL MOUNT

COLORS AVAILABLE

GL = BRIGHT GOLD
BG = BRUSHED GOLD

SL = BRIGHT SILVER
BS = BRUSHED SILVER

BK = BRIGHT BLACK
(1 7/8" ID)

FLARED STYLE

SLIDE-IN STYLE



UNIQUELY DESIGNED WALL MOUNT ROD HOLDERS MANUFACTURED WITH MARINE GRADE ALUMINUM AND AVAILABLE IN THE FOLLOWING STYLES: FLARED AND SLIDE-IN. ALL ROD HOLDERS ARE METICULOUSLY POLISHED AND ANODIZED IN A VARIETY OF MARINE GRADE ANODIZED FINISHES. INCLUDES HEAVY WHITE LINER.

FLARED STYLE

#66500 - WRH 10"-GL

#66501 - WRH 10"-BG

#66502 - WRH 10"-SL

#66503 - WRH 10"-BS

#66504 - WRH 10"-BK

SLIDE IN STYLE

#66510 - WRHSI 10"-GL

#66511 - WRHSI 10"-BG

#66512 - WRHSI 10"-SL

#66513 - WRHSI 10"-BS

#66514 - WRHSI 10"-BK

ALUMINUM GUNNEL MOUNT ROD HOLDERS

OVAL, ROUND OR 3" X 4" RECTANGULAR MOUNTING PLATE.

AVAILABLE IN POLISHED ALUMINUM OR BRUSHED FINISH.

1 5/8" ID X 2" OD X 8.5" L.



#66700-

0° ROUND HEAD

#66701-

15° ROUND HEAD

#66702-

30° ROUND HEAD

#66703-

0° WELD-ON SQUARE HEAD

#66704-

15° WELD-ON SQUARE HEAD

#66705-

30° WELD-ON SQUARE HEAD

#66706-

0° OVAL HEAD

#66707-

15° OVAL HEAD

#66708-

30° OVAL HEAD

ALUMINUM PADS

Pictures in Order Left to Right with list



- #66800 - D-503-P 5" - 3 HOLE POLISHED
- #66801 - D-453-B 4.5" - 3 HOLE BRUSHED
- #66802 - D-453-P 4.5" - 3 HOLE POLISHED
- #66803 - D-403B 4" - 3 HOLE BRUSHED
- #66804 - D-403-P 4" - 3 HOLE POLISHED
- #66805 - D-353-P 3.5" - 3 HOLE POLISHED
- #66806 - D-303-P 3" - 3 HOLE POLISHED
- #66807 - D-253-B 2.5" - 3 HOLE BRUSHED
- #66808 - D-504-P 5" - 4 HOLE POLISHED
- #66809 - D-454-P 4.5" - 4 HOLE POLISHED
- #66810 - OSD-354-P 3.5" - 4 HOLE OFFSET POLISHED
- #66811 - D-404-P 4" - 4 HOLE POLISHED
- #66812 - D-404-B 4" - 4 HOLE BRUSHED
- #66813 - D-304-P 3" - 4 HOLE POLISHED
- #66814 - D-304-B 3" - 4 HOLE BRUSHED
- #66815 - OSD-404S-B 4" - 4 HOLE OFFSET BRUSHED
- #66816 - D-251-B 2.5" BRUSHED
- #66850 - OB-4060-P 4" X 6" OVAL POLISHED
- #66851 - OB-4060S-P 4" X 6" OVAL OFFSET POLISHED
- #66852 - OB-4060S-B 4" X 6" OVAL OFFSET BRUSHED
- #66853 - OB-2540-P 2.5" X 4" POLISHED
- #66854 - OB-2540-B 2.5" X 4" BRUSHED
- #66855 - OB-3040-P 3" X 4" POLISHED
- #66856 - OB-3040-B 3" X 4" BRUSHED
- #66857 - DP-2035-B 2" X 3.5" DIAMOND BRUSHED
- #66858 - RP-2540-B 2.5" X 4" RECTANGULAR PAD BRUSHED
- #66859 - RP-3040S-P 3" X 4" RECTANGULAR PAD POLISHED
- #66860 - RP-3040C-B 3" X 4" RECTANGULAR PAD BRUSHED
- #66861 - RP-3555C-P 3.5" X 5.5" RECTANGULAR PAD POLISHED
- #66862 - RP-2050-B 2" X 5" RECTANGULAR PAD BRUSHED
- #66863 - RP-2040-B 2" X 4" RECTANGULAR PAD BRUSHED
- #66864 - RP-20275-B 2" X 2 3/4" RECTANGULAR PAD BRUSHED
- #66865 - RP-15325-B 1 1/2" X 3 1/4" RECTANGULAR PAD BRUSHED
- #66866 - RP-1530-B 1 1/2" X 3" RECTANGULAR PAD BRUSHED

ALUMINUM T-TOP & TOWER PINS

ALL PINS INCLUDE SCREW AND WASHER, AVAILABLE IN MILL FINISH AND POLISHED ANODIZED. *SIZES AVAILABLE ARE 3/4", 1", 1 1/4", 1 1/2" AND 2"

*GRAB RAIL CONNECTORS AND HOLLOW THRU SUPPORTS AVAILABLE FOR ROUND AND OVAL PIPES. *VARIOUS MOUNT PLATE DESIGNS AVAILABLE.

Add to part #'s for differant sizes:
 = 3/4"
 -1 = 1"
 -2 = 1 1/4"
 -3 = 1 1/2"
 -4 = 2"



- #66900 - *FMP-1000W FEMALE/MALE PIN
- #66901 - *FMP-1000S FEMALE/MALE PIN
- #66902 - *WHP-1000 FEMALE/MALE PIN WIDE SLOT
- #66903 - *BAP-1000 BREAK-AWAY PIN
- #66904 - *FRC-1000 FOLDING FOOT REST WELD-ON PIN
- #66905 - *FPO-1000 FEMALE PIN
- #66906 - *WHP-1000 WIDE HALF PIN
- #66908 - GRC-002R 2' GRAB RAIL CONNECTOR ROUND
- #66909 - GRC-003R 3" GRAB RAIL CONNECTOR ROUND
- #66910 - GRCO-002O 2" GRAB RAIL CONNECTOR OVAL
- #66911 - GRCO-003O 3" GRAB RAIL CONNECTOR OVAL
- #66912 - GRCHT-002R 2" GRAB RAIL CONNECTOR ROUND HOLLOW THRU
- #66913 - GRCHT-003R 3" GRAB RAIL CONNECTOR ROUND HOLLOW THRU
- #66914 - GRCHT-002O 2' GRAB RAIL CONNECTOR OVAL HOLLOW THRU
- #66915 - GRCHT-003O 3" GRAB RAIL CONNECTOR OVAL HOLLOW THRU

NEW PRODUCTS

OFFSET TRIPLE ROD HOLDER w/STORAGE CUPS

THIS QUALITY ROD HOLDER CAN BE USED FOR ROD STORAGE AND IS MOST USEFUL IN KITE FISHING. THE CUPS ALLOW FOR HOLDING YOUR RIGGING TOOLS AS WELL AS YOUR DRINK.



CONSTRUCTED OF ANODIZED ALUMINUM AND WHITE LINER TO PROTECT YOUR RODS. PROUDLY MADE IN THE USA. TUBE ID 1 7/8" BASE OD 1.49".

#88149 STRAIGHT BUTT WITH CUP HOLDERS

OFFSET TRIPLE ROD HOLDER

OUR QUALITY TRIPLE OFFSET CAN BE USED PORT OR STARBOARD FOR EITHER ADDITIONAL ROD STORAGE OR FOR KITE FISHING. CONSTRUCTED OF ANODIZED ALUMINUM AND PROUDLY MADE IN THE USA. TUBE ID 1 7/8" BASE OD 1.49".



#88149-1 STRAIGHT BUTT

TRIPLE BOLT-ON ARRAY

DESIGNED TO INCREASE YOUR ROD STORAGE, CONSTRUCTED OF COLD DRAWN ALUMINUM WITH BRUSHED FINISH AND WHITE LINER TO PROTECT YOUR RODS. PROUDLY MADE IN THE USA.



#88145 TRIPLE BOLT-ON

SINGLE BOLT-ON ROD HOLDER

THIS VERSATILE ROD HOLDER CAN BE MOUNTED ON YOUR GUNNEL, TRANSOM OR JUST ABOUT ANYWHERE YOU NEED ADDITIONAL ROD STORAGE. CONSTRUCTED OF ANODIZED ALUMINUM WITH WHITE LINER TO PROTECT YOUR RODS. PROUDLY MADE IN THE USA.



#88146 SINGLE BOLT ON

SPINNING ROD HOLDER

DESIGNED SPECIFICALLY TO STORE YOUR SPINNING RIGS. THE CUT OUT AREA ALLOWS FOR YOUR SPINNING REEL TO FIT COMFORTABLY IN THIS HIGH POLISHED ANODIZED ALUMINUM ROD HOLDER WITH WHITE LINER TO PROTECT YOUR REEL AND ROD BUTT. PROUDLY MADE IN THE USA.



#88147 SPINNING ROD HOLDER

HARD TOP ROD HOLDER MOUNT



DESIGNED SPECIFICALLY TO BE MOUNTED TO YOUR HARD TOP FOR ADDITIONAL ROD STORAGE. SIMPLE MOUNTING LEGS ALLOW FOR EASE OF INSTALLATION. CONSTRUCTED OF COLD DRAWN ANODIZED ALUMINUM WITH WHITE LINERS TO PROTECT YOUR ROD. AVAILABLE WITH EITHER 4 ROD HOLDERS OR 6 ROD HOLDERS AS SHOWN. PROUDLY MADE IN THE USA.

#88148 SIX HARD TOP ROD HOLDER MOUNT

#88148-1 FOUR HARD TOP ROD HOLDER MOUNT

T-TOP & TOWER IN-LINE LED LIGHTS

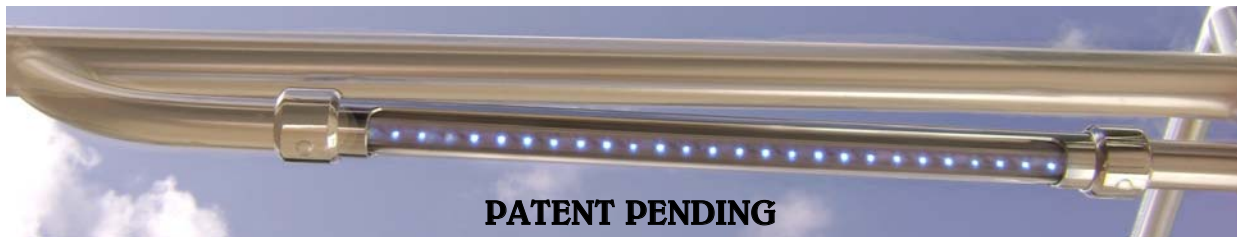

PATENT PENDING



IN-LINE ALUMINUM LED LIGHTS

MAKE YOUR T-TOP OR TUNA TOWER LOOK AS THOUGH IT CAME WITH LIGHTING. ENHANCE IT WITH THESE POLISHED ALUMINUM IN-LINE LED LIGHTS. AVAILABLE FOR THE NON-STRUCTURAL PART OF YOUR 1" (1.315) ALUMINUM SCHEDULE 40 PIPE. INCLUDES THE NECESSARY COUPLERS FOR INSTALLATION. MAY BE INSTALLED OVER-HEAD, ON T-TOP SIDE RAIL AND IN MANY OTHER LOCATIONS WHERE YOU MAY ENJOY EXTRA LIGHTING. SIMPLY CUT 12 OR 20" OUT OF YOUR NON-STRUCTURAL SCHEDULE 40 ALUMINUM PIPE AND PLACE IN. 12" AND 20" INLINES OFFERS LOW POWER CONSUMPTION, LOW GLARE AND LONG LIFE, 12V DC POWER ONLY. HIGH EFFICIENCY STRIPS ARE WATERPROOF (NOT TO BE SUBMERGED).

#88985	20" x 1" (1.315) DAY LIGHT WHITE	#88985-4	12" x 1" (1.315) Day Light White
#88985-1	20" x 1" (1.315) NIGHT VISION RED	#88985-5	12" x 1" (1.315) Night Vision Red
#88985-2	20" x 1" (1.315) DUAL RED/WHITE	#88985-6	12" x 1" (1.315) Blue
#88985-3	20" x 1" (1.315) BLUE	#88985-8	12" x 1" (1.315) Dual Blue/White
#88985-7	20" x 1" (1.315) DUAL BLUE/WHITE		
#88985-9	20" x 1" (1.315) MULTICOLOR W/CONTROLLER & SWITCH		

HAND RAIL LED LIGHTS

PATENT PENDING



LIGHT UP YOUR HAND RAIL !!!

ILLUMINATE YOUR PASSAGE WAYS WITH OUR NEW LED HAND RAILS. PLACE THEM ON ANY FLAT SURFACE WHERE LIGHTING IS NEEDED TO MOVE SAFELY AROUND YOUR BOAT.

#88997	20" DAY LIGHT WHITE	#88997-4	12" DAY LIGHT WHITE
#88997-1	20" NIGHT VISION RED	#88997-5	12" NIGHT VISION RED
#88997-2	20" DUAL RED/WHITE	#88997-6	12" BLUE
#88997-3	20" BLUE	#88997-9	12" DUAL BLUE/WHITE
#88997-7	20" DUAL BLUE/WHITE		
#88997-8	20" MULTICOLOR W/CONTROLLER & SWITCH		

CLAMP-ON LED LIGHTS & LED LIGHT STRIPS

(NEW) Multicolor LED Strip

NOW A 20" LED STRIP THAT ALLOWS YOU TO CHANGE COLOR AND FREQUENCY WITH THE PRESS OF A SWITCH. THESE LED STRIPS FROM TIGRESS INCLUDE A CONTROLLER TO OPERATE THE FUNCTION AS WELL AS THE FREQUENCY OF THE DISPLAYED LIGHTS. MOUNT UP TO 10 STRIPS IN SERIES USING ONLY ONE CONTROLLER & REMOTE. PROGRAM YOUR LIGHTS TO DISPLAY ONE COLOR OR 15 DIFFERANT SHADES. COLORS INCLUDE WHITE, RED, BLUE, GREEN, YELLOW, LIGHT BLUE, ORANGE AND VARYING SHADES OF EACH COLOR. ALSO AVAILABLE IN ALL OF OUR LIGHT HOUSINGS AS SHOWN ON ALL THREE PAGES. COLOR PATTERNS BELOW.



- * REMOTE CONTROL DISTANCE UP TO 120 FT
- * DC INPUT 12/24V
- * MULTI-MODE TO SELECT, WITH PAUSE FUNCTION
- * 0 -100% BRIGHTNESS ADJUSTMENT
- * 8 LEVELS OF SPEED ADJUSTMENT

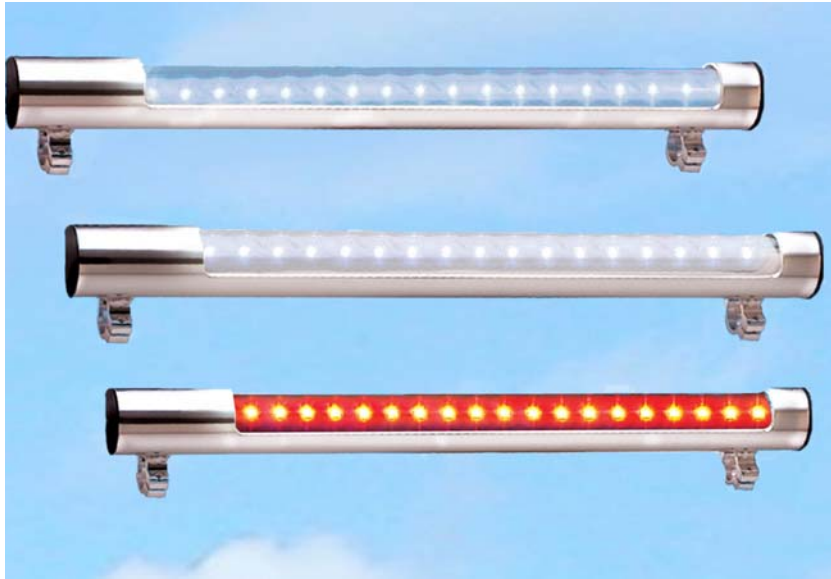
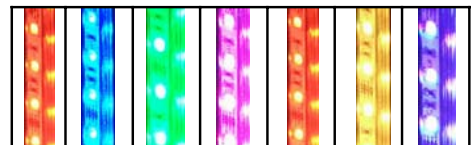

ENHANCE YOUR T-TOP OR TUNA TOWER WITH OUR BRIGHT FINISHED ALUMINUM CLAMP-ON LIGHTS. FITS NON-STRUCTURAL 3/4" (1.05) TO 1" (1.315) ALUMINUM SCHEDULE PIPE. MAY BE INSTALLED OVERHEAD, ON T-TOP, SIDE RAIL AND IN MANY OTHER LOCATIONS THAT YOU HAVE 3/4" - 1" IPS PIPE. WATERPROOF (NOT TO BE SUBMERGED)

CLAMP-ON LED LIGHT COVERS

BOX INCLUDES BUSHING TO REDUCE FROM 1" TO 3/4"

- #88990 - 12" X 3/4" - 1" DAY LIGHT WHITE
- #88991 - 12" X 3/4" - 1" NIGHT VISION RED
- #88991-2 12" X 3/4" - 1" BLUE
- #88991-3 12" X 3/4" - 1" DUAL BLUE/WHITE
- #88980 - 20" X 3/4" - 1" DAY LIGHT WHITE
- #88981 - 20" X 3/4" - 1" NIGHT VISION RED
- #88982 - 20" X 3/4" - 1" DUAL RED/WHITE
- #88982-1 20" X 3/4" - 1" BLUE
- #88982-2 20" X 3/4" - 1" DUAL BLUE/WHITE
- #88982-3 20" X 3/4" - 1" **MULTICOLOR** w/CONTROLLER & SWITCH

HIGH EFFICIENCY LED LIGHTS STRIPS

- #88995 - 12" BRIGHT WHITE
- #88995-1 12" NIGHT VISION RED
- #88995-2 12" BLUE
- #88995-3 12" DUAL BLUE/WHITE
- #88996 20" BRIGHT WHITE
- #88996-1 20" NIGHT VISION RED
- #88996-2 20" BLUE
- #88996-3 20" DUAL RED/WHITE
- #88996-4 20" DUAL BLUE/WHITE
- #88996-5 20" **MULTICOLOR** w/CONTROLLER & REMOTE
- #88996-6 20" **MULTICOLOR** STRIP ONLY

LED LIGHT STRIPS CAN BE USED TO REPLACE YOUR EXISTING LED LIGHT OR CAN BE PLACED UNDER YOUR GUNNEL, ENGINE ROOM, ANYWHERE YOU CAN IMAGINE AND WILL GIVE YOUR BOAT THE PIZZAZZ AND COLOR YOUR LOOKING FOR.

- * 12" STRIP'S DRAW BLUE OR WHITE 1.4A RED OR BLUE-WHITE 2.8A @ 12V DC POWER.
- * 20" STRIPS DRAW BLUE AND WHITE 2.4A RED, RED-WHITE AND BLUE-WHITE /4.8A @ 12V DC POWER.
- * HIGH EFFICIENCY LED'S ALSO OFFER LOW POWER CONSUMPTION, LOW GLARE, LONG LIFE AND ARE WATER-PROOF (NOT TO BE SUBMERGED).

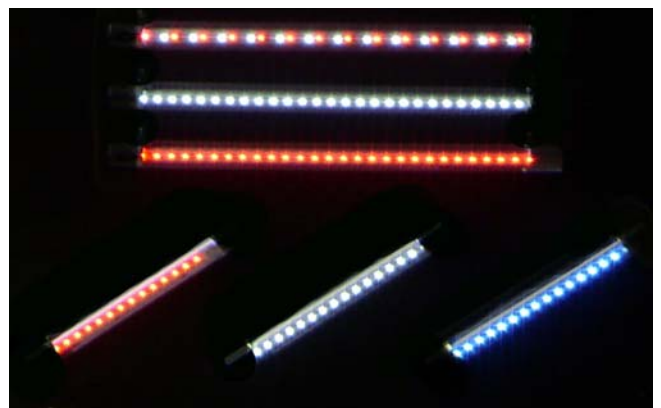

ALUMINUM BRACKET, CENTER AND WELD-ON

NEW



Bracket Mount



Bracket Mount



Center Bracket Mount

BRACKET MOUNT	BRACKET MOUNT	CENTER MOUNT	WELD-ON
#88977 - 20" DAY LIGHT WHITE	SILVER/GOLD/BLACK (CONT.)	#88979 - 20" DAY LIGHT WHITE	#88993 - 20" DAY LIGHT WHITE
#88977-1 20" NIGHT VISION RED	#88987 - 12" DAY LIGHT WHITE	#88979-1 20" NIGHT VISION RED	#88993-1 20" NIGHT VISION RED
#88977-2 20" DUAL RED/WHITE	#88987-1 12" NIGHT VISION RED	#88979-2 20" DUAL RED/WHITE	#88993-2 20" DUAL RED/WHITE
#88977-3 20" BLUE	#88987-2 12" BLUE	#88979-3 20" BLUE	#88993-3 20" BLUE
#88977-4 20" DUAL BLUE/WHITE	#88987-3 12" DUAL BLUE/WHITE	#88979-4 20" DUAL BLUE/WHITE	#88993-4 20" DUAL BLUE/WHITE
#88977-5 20" MULTICOLOR	BRACKET MOUNT SILVER/GOLD	#88979-5 20" MULTICOLOR	#88993-5 20" MULTICOLOR
w/CONTROLLER & SWITCH	#88988 - 20" DAY LIGHT WHITE	w/CONTROLLER & SWITCH	w/CONTROLLER & SWITCH
#88978 12" DAY LIGHT WHITE	#88988-1 20" NIGHT VISION RED	#88992 - 12" DAY LIGHT WHITE	#88994 - 12" DAY LIGHT WHITE
#88978-1 12" NIGHT VISION RED	#88988-2 20" DUAL RED/WHITE	#88992-1 12" NIGHT VISION RED	#88994-1 12" NIGHT VISION RED
#88978-2 12" BLUE	#88988-3 20" BLUE	#88992-2 12" BLUE	#88994-2 12" BLUE
#88978-3 12" DUAL BLUE/WHITE	#88988-4 20" DUAL BLUE/WHITE	#88992-3 12" DUAL BLUE/WHITE	#88994-3 12" DUAL BLUE/WHITE
BRACKET MOUNT	#88988-5 20" MULTICOLOR		
SILVER/GOLD/BLACK	w/CONTROLLER & SWITCH		
#88986 - 20" DAY LIGHT WHITE	#88989 - 12" DAY LIGHT WHITE		
#88986-1 20" NIGHT VISION RED	#88989-1 12" NIGHT VISION RED		
#88986-2 20" DUAL RED/WHITE	#88989-2 12" BLUE		
#88986-3 20" BLUE	#88989-3 12" DUAL BLUE/WHITE		
#88986-4 20" DUAL BLUE/WHITE			
#88986-5 20" MULTICOLOR			
w/CONTROLLER & SWITCH			



Weld-On





STANDARD
US POSTAGE PAID
FORT LAUD., FL
PERMIT NO 1915

TIGRESS TRADING COMPANY, INC.
FORT LAUDERDALE, FL

PHONE: 954-462-0917 FAX: 954-524-0441
E-MAIL: TIGRESSTRD@AOL.COM
WEB SITE: WWW.TIGRESSOUTRIGGERS.COM

Or Current Resident/Occupant

TIGRESS WARRANTY

TIGRESS TRADING CO., INC. PRODUCTS ARE WARRANTED AGAINST MATERIAL AND/OR MANUFACTURING DEFECTS FOR A PERIOD OF 1 YEAR, FROM DATE OF PURCHASE. THIS WARRANTY IS LIMITED TO THE REPAIR AND/OR REPLACEMENT OF MERCHANDISE THAT PROVES TO BE DEFECTIVE IN MATERIAL AND/OR WORKMANSHIP. NOTE: PROOF OF PURCHASE MUST ACCOMPANY ALL PRODUCTS SUBMITTED FOR WARRANTY.

Table of Contents

- PAGE 1 - TIGER SHARK ELECTRIC TOP MOUNT
- PAGE 2 - **(New)** TIGER SHARK MANUAL TOP MOUNTS
- PAGE 3 - **(New)** TELESCOPING ALUMINUM, TELESCOPING CARBON GRAPHITE OUTRIGGERS & CENTER RIGGER
- PAGE 4 - **(New)** FIXED & TELESCOPING OUTRIGGERS - CENTER RIGGERS - OUTRIGGER ACCESSORIES
- PAGE 5 - OUTRIGGER SYSTEMS
- PAGE 6 - OUTRIGGER SYSTEMS - CENTER RIGGER SYSTEM
- PAGE 7 - OUTRIGGER HOLDERS, TOP MOUNT - CLAMP ON - ROD HOLDER/OUTRIGGER HOLDERS - T-TOP WEDGES
- PAGE 8 - FLUSH MOUNT - SIDE MOUNT OUTRIGGER HOLDERS - CENTER RIGGER HOLDER - EXTRUSIONS - BACKING PLATES
- PAGE 9 - PREMIUM OUTRIGGERING KITS
- PAGE 10 - PREMIUM SNUBBERS - OUTRIGGER ACCESSORIES
- PAGE 11 - **(New)** KITE ACCESSORIES & KITE ROD HOLDER ARRAYS
- PAGE 12 - **(New)** BITE THIS KITES & DIRECTIONS
- PAGE 13 - **(New)** ROD HOLDERS - SIDE, GUNNEL, PIVOTING - REPLACEMENT INSERTS - GIMBALS - ROD HOLDER EXTENDERS
- PAGE 14 - **(New)** FLUSH ROD HOLDERS
- PAGE 15 - ROD HOLDER ACCESSORIES - CLAMP-ON ROD HOLDERS
- PAGE 16 - MEASURING YOUR CLAMP-ONS, CLAMP-ON OUTRIGGER HOLDERS AND ALUMINUM CLAMP-ON LED LIGHTS
- PAGE 17 - SEA TIGER ROD HOLDERS - REEL HANGERS
- PAGE 18 - ROD HANGERS - GAFFS - HINGES
- PAGE 19 - LONG WEDGE & SHORT WEDGE WELD-ON ROD HOLDERS
- PAGE 20 - SHORT WEDGE & TUBE WELD-ON ROD HOLDERS
- PAGE 21 - PLAIN WELD-ON - GUNNEL & WALL MOUNT ROD HOLDERS
- PAGE 22 - T-TOP ALUMINUM PADS - T-TOP PINS
- PAGE 23 - **(New)** ROD HOLDERS
- PAGE 24 - INLINE & GRAB RAIL LED LIGHTS
- PAGE 25 - CLAMP-ON LED LIGHTS & LED LIGHT STRIPS
- PAGE 26 - BRACKET - CENTER & WELD ON LED LIGHTS

"Tigress® Quality" Accept No IMITATIONS

SINCE OUR INCEPTION 21 YEARS AGO, TIGRESS' MISSION HAS BEEN TO RAISE THE BAR FOR INNOVATION, QUALITY, EASE OF USE, AND CONVENIENCE ON OUR PRODUCTS OFFERED TO THE SALT WATER SPORTS FISHING INDUSTRY.

ALL TIGRESS® ALUMINUM OUTRIGGERS ARE CONSTRUCTED OF COLD DRAWN ALUMINUM FOR MAXIMUM STRENGTH AND DURABILITY. WE THEN USE A STATE OF THE ART ANODIZING PROCESS TO PROTECT & ENHANCE OUR PRODUCTS.

EVERY ACCESSORY IS CONSTRUCTED OF THE BEST MATERIALS WE COULD FIND TO GIVE THE MAXIMUM SERVICE AND LIFE.

TIGRESS® USES ONLY 300 SERIES STAINLESS OR 316 STAINLESS STEEL IN EVERY ROD HOLDER OR PAIR OF OUTRIGGER HOLDERS.

"Say Hello to Simplicity"

OUR PATENT PENDING TIGERSHARK I ELECTRONICALLY OPERATED LINERIGGER AND OUR TIGERSHARK II MANUALLY OPERATED LINERIGGER OFFER THE USER THE "SIMPLICITY" OF DEPLOYING THEIR OUTRIGGERS BOTH UP AND OUT TO THE FISHING POSITION IN ONE STEP. A SIMPLE PUSH OF THE CONTROL SWITCH FOR THE ELECTRONIC VERSION OR A FEW CRANKS OF THE HANDLE FOR THE MANUAL VERSION AND YOU ARE FISHING.

TIGRESS® TIGER FISH AND TIGER FISH II TOP MOUNT OUTRIGGER HOLDERS ALLOW THE USER TO DEPLOY HIS OUTRIGGERS FROM THE SAFETY AND CONVENIENCE OF HIS CONSOLE. NO MORE STANDING ON THE GUNNEL IN HEAVY SEAS TRYING NOT TO FALL OVERBOARD WHILE DEPLOYING YOUR OUTRIGGERS. SIMPLY PULL DOWN THE HANDLE AND MOVE YOUR OUTRIGGER TO SELECT ONE OF MULTIPLE FISHING POSITIONS.

WE HAVE AND WILL CONTINUE TO EXPAND OUR QUALITY OFFERINGS OF FINE PRODUCTS AND ACCESSORIES MAKING THE TIGRESS® PRODUCT LINE OF OUTRIGGERS AND GEAR THE STANDARD OF QUALITY AND EXCELLENCE.

"SETTING THE BAR FOR INNOVATION, QUALITY, EASE OF USE, AND CONVENIENCE."